

HOT SPOT[®]



HOT SPOT[®] SPAS

Tempo[®] • Rhythm[®] • Relay[®] • SX • TX

OWNER'S MANUAL

From the makers of



HOT SPOT

From the makers of



**Watkins Wellness[®] congratulates you on your decision to enjoy the finest spa available...
Welcome to the growing family of HOT SPOT spa owners.**

Before you begin reviewing the manual, please take a moment to register your warranty. Doing so will assist us in contacting you for any important product notification.

Prior to registering, you will need the serial number that is located within the equipment compartment of your **HOT SPOT** spa.

To register please go to <http://www.hotspring.com/hot-tub-owners/hot-tub-product-warranty-registration> or simply scan the QR code below:



FOR YOUR RECORDS

Spa Model/Serial Number: _____

Date Purchased: _____

Dealer: _____

Address: _____

Cover Serial Number: _____

Accessory Serial Number: _____

If you have any questions about any aspect of your spa's set-up, operation or maintenance, contact your authorized **HOT SPRING** dealership. They are trained professionals who are familiar with the product as well as new spa ownership concerns. Their expertise will facilitate the enjoyment of your new **HOT SPOT** spa.

IMPORTANT: WATKINS WELLNESS reserves the right to change specifications, or design, without notification and without incurring any obligation.



In most cities and counties, permits will be required for the installation of electrical circuits or the construction of exterior surfaces (decks and gazebos). In addition, some communities have adopted residential barrier codes which may require fencing and/or self-closing gates on the property to prevent unsupervised access to a pool (or spa) by children under 5 years of age. Your **HOT SPOT** spa is equipped with a locking cover that meets the ASTM F1346-91 Standard for Safety Covers and as a result, is usually exempt from most barrier requirements. As a general practice, your local Building Department will inform you of any applicable barrier requirements at the time a permit is obtained for the installation of an electrical circuit. Your **HOT SPRING** dealer can provide information on which permits may be required.

TABLE OF CONTENTS

SAFETY INFORMATION

IMPORTANT SAFETY INSTRUCTIONS.....	1
IMPORTANT SPA INSTRUCTIONS.....	3

GETTING STARTED

SPA FEATURES TEMPO, RELAY & RHYTHM MODELS..	4
SPA FEATURES SX & TX MODELS.....	5
QUICK START-UP INSTRUCTIONS	6
START-UP	7
PRIMING THE PUMP(S).....	8

WATER QUALITY AND MAINTENANCE

BASIC INFORMATION.....	9
HOW TO ADD CHEMICALS TO THE WATER.....	9
FUNDAMENTALS OF WATER MAINTENANCE	10
FROG® WATER CARE SYSTEM.....	11
FROG CARTRIDGE REPLACEMENT INSTRUCTIONS..	11
THE HOT SPOT SPA WATER MAINTENANCE PROGRAM.....	11
VACATION WATER CARE INSTRUCTIONS.....	13
WATER TERMINOLOGY	14

OPERATING INSTRUCTIONS

SPA CONTROL PANEL.....	15
SYSTEM MODE	15
CLEANING MODE.....	15
TOOLS MENU.....	16
AUDIO MENU (OPTIONAL).....	17

JET MENU

TEMPO® (MODEL TEM).....	20
RELAY® (MODEL REL)	21
RHYTHM® (MODEL RHY).....	22
SX (MODEL SX)	23
TX (MODEL TX)	24

SPA CARE AND MAINTENANCE

DRAIN & REFILL INSTRUCTIONS.....	25
PREVENTION OF FREEZING	25
FILTER SYSTEM	26
FILTER CARTRIDGES REMOVAL & CLEANING	26
CARE OF THE SPA PILLOWS.....	26
CARE OF THE EXTERIOR.....	27
CARE OF THE SPA CABINET	27
CARE OF THE SPA COVER	27
COVER LIFTER SYSTEM.....	27

ELECTRICAL REQUIREMENTS

230 VOLT PERMANENTLY CONNECTED MODELS	29
230 VOLT CONVERSION 30 OR 50 AMP (SX & TX ONLY).....	30
115 VOLT CONVERSION 30 AMP (SX & TX ONLY).....	30
115 VOLT GFCI SX & TX.....	31
115 VOLT OPERATION (60Hz ONLY)	31

SERVICE INFORMATION

GENERAL INFORMATION	32
GFCI AND HIGH LIMIT THERMOSTAT	32
MISCELLANEOUS SERVICE INFORMATION.....	32
ACTS INVALIDATING WARRANTY	32
DISCLAIMERS.....	32
WATKINS WELLNESS CUSTOMER SERVICE	33
TROUBLESHOOTING	33
TROUBLESHOOTING	34
SPA SPECIFICATIONS	35

SAFETY INFORMATION

IMPORTANT SAFETY INSTRUCTIONS

(READ AND FOLLOW ALL INSTRUCTIONS)

AVOIDING THE RISK TO CHILDREN

DANGER - RISK OF CHILD DROWNING

Extreme caution must be exercised to prevent unauthorized access by children. To avoid accidents, ensure that children cannot use a spa unless they are supervised at all times.

WARNING

To reduce the risk of injury, do not permit children to use this spa unless they are closely supervised at all times.

- To reduce the risk of injury, lower water temperatures are recommended for young children. Children are especially sensitive to hot water.
- Extreme caution must be exercised to prevent unauthorized access by children. To avoid accidents, ensure that children cannot use a spa unless they are supervised at all times.

DO:

- Make sure you always lock the child resistant locks after using the spa for your children's safety. Every **HOT SPOT** spa is equipped with a locking cover that meets the ASTM F1346-91 Standard for Safety Covers.
- Test the water temperature with your hand before allowing children to enter the spa to be sure that it's comfortable. Children are especially sensitive to hot water.
- Remind children that wet surfaces can be very slippery. Make sure that children are careful when entering or exiting the spa.

DON'T:

- Allow children to climb onto the spa cover.
- Allow children to have unsupervised access to the spa.

AVOIDING THE RISK OF ELECTROCUTION

DANGER - RISK OF ELECTROCUTION

- Connect only to a grounded source.
- Do not bury the power cord. A buried power cord may result in death, or serious personal injury due to electrocution if direct burial-type cable is not used, or if improper digging occurs.
- A ground terminal (pressure wire connector) is provided on the control box inside the unit to permit connection of a minimum No. 8 AWG (8.4 mm²) solid copper bonding conductor between this point and any metal equipment, metal water pipe, metal enclosures of electrical equipment, or conduit within five feet (1.5 m) of the unit as needed to comply with local requirements.

- Do not operate the audio main controls while inside the spa (if spa is equipped with an audio component).
- Do not connect any auxiliary components (for example, cable additional speakers, headphones, additional audio components) to the audio system unless approved by **WATKINS WELLNESS**.
- Do not self service audio component by opening spa door as this may expose dangerous voltage or other risk of injury. Refer all servicing to qualified service personnel.
- Do not attach an external antennae to a spa audio system unless installed by a licensed electrician in accordance with Article 810 of the National Electric Code, ANSI/NFPA 70.

WARNING

- To reduce the risk of electrical shock, replace a damaged cord immediately. Failure to do so may result in death or serious personal injury due to electrocution.
- Your spa is provided with a Ground Fault Circuit Interrupter (GFCI) for user and equipment protection. To ensure proper operation of this important safety device, test according to the following instructions per electrical configuration.
- **Cord-Connected 115 volt, 15 or 20 amp models:** The GFCI is located at the end of the power cord. Before each use, with the unit operating, push the TEST button. The unit should stop operating and the GFCI power indicator will go out. Wait 30 seconds and then reset the GFCI by pushing the RESET button. The GFCI power indicator will turn on, restoring power to the spa. If the interrupter does not perform in this manner, there may be an electrical malfunction and with it, the possibility of an electric shock. Disconnect the power until the problem has been corrected.
- **115 volt 30 amp hard wired, 230 volt permanently installed or converted models:**
 - A ground terminal is provided on the terminal block (TB-1, system ground terminal) located inside the control box. To reduce the risk of electric shock, connect this terminal to the grounding terminal of your electrical service or supply panel with a continuous green, insulated copper wire. The wire must be equivalent in size to the circuit conductors supplying the equipment. In addition, a bonding terminal (pressure wire connector) is provided on the outside of the control box for bonding to local ground points. To reduce the risk of electric shock, this connector should be bonded with a No. 8 AWG (8.4 mm²) solid copper wire to any metal ladders, water pipes, or other metal within 5 feet (1.5 m) of the spa to comply with local requirements. The means of disconnection must be readily accessible, but must be installed at least 5 feet (1.5 m) from the spa.
 - Your spa is provided with a suitably rated circuit breaker to open all ungrounded supply conductors.
 - Your spa uses ground fault circuit interrupters in the electrical subpanel. Before each use of the spa and with the unit operating, push the TEST button on each breaker. The switch should click over to the "Trip" position. Wait 30 seconds and reset each GFCI breaker by switching it completely off and then completely on. The switch should then stay on. If either of the interrupters does not perform in this manner, it is an indication of an electrical malfunction and the possibility of an electric shock. Disconnect the power until the fault has been identified and corrected.

IMPORTANT: Failure to wait 30 seconds before resetting the GFCI may cause the spa's Power Indicator (on the control panel) to blink. If this occurs, repeat the GFCI test procedure.

DANGER - RISK OF ELECTRICAL SHOCK

- Install at least 5 feet (1.5 m) from all metal surfaces. A spa may be installed within 5 feet of a metal surface if each metal surface is permanently connected by a minimum No. 8 AWG (8.4 mm²) solid copper conductor attached to the wire ground connector on the terminal box that is provided for this purpose if in accordance with National Electrical Code ANSI/NMFA70-1993.
- Do not permit any electrical appliances, such as a light, telephone, radio, or television within 5 feet (1.5 m) of a spa. Failure to maintain a safe distance may result in death, or serious personal injury due to electrocution, if the appliance should fall into the spa.
- Install your spa in such a way that drainage is away from the electrical compartment and from all electrical components.

DO:

- Be sure your spa is connected to the power supply correctly - use a licensed electrical contractor.
- Disconnect the spa from the power supply before draining the spa or servicing the electrical components.
- Test the Ground Fault Circuit Interrupter(s) before each use.
- Replace audio components only with identical components (if your spa is equipped with an audio component).

DON'T:

- Use the spa with the equipment compartment door removed.
- Place electrical appliances within 5 feet (1.5m) of the spa.
- Use an extension cord to connect the spa to its power source. The cord may not be properly grounded and the connection is a shock hazard. An extension cord may cause a voltage drop, which will cause overheating of the jet pump motor and motor damage.
- Attempt to open the electrical control box. There are no user serviceable parts inside.

RISKS TO AVOID

DANGER - RISK OF INJURY

- To reduce the risk of injury to persons, DO NOT remove suction fittings (filter standpipes) located in the filter compartment.
- The suction fittings in the spa are sized to match the specific water flow created by the pump. Never replace a suction fitting with one rated less than the flow rate marked on the original suction fitting.
- There is a danger of slipping and falling. Remember that wet surfaces can be very slippery. Take care when entering or exiting the spa.
- Never operate spa if the suction fittings are broken or missing.
- People with infectious diseases should not use the spa.
- Keep any loose articles of clothing, long hair, or hanging jewelry away from rotating jets or other moving components.

INCREASED SIDE EFFECTS OF MEDICATION

- The use of drugs, alcohol may cause unconsciousness with the possibility of drowning.
- Persons using medications should consult a physician before using a spa; some medication may cause a user to become drowsy, while other medication may affect heart rate, blood pressure, and circulation.
- Persons taking medications which induce drowsiness, such as tranquilizers, antihistamines, or anticoagulants should not use the spa.

HEALTH PROBLEMS AFFECTED BY SPA USE

- Pregnant women should consult a physician before using spa.
- Persons suffering from obesity, or with a medical history of heart disease, low or high blood pressure, circulatory system problems, or diabetes should consult a physician before using spa.

UNCLEAN WATER

- Keep the water clean and sanitized with correct chemical care. The recommended levels for your **HOT SPRING** spa are:

With FROG @ease SmartChlor will maintain a 0.5-1.0 ppm free chlorine as long as water is balanced	Without FROG @ease Free Available Chlorine: 3.0-5.0 ppm	Bromine: 1.0-2.0 with minerals 3.0-5.0 without minerals
Water pH: 7.2-7.8	Calcium Hardness: 50-150 ppm	Total Alkalinity: 40-120 ppm

- Refer to Water Quality and Maintenance section for complete instructions.

IMPORTANT: Turn on the jet pump for a least ten minutes after adding ANY spa water chemicals into the filter compartment.

Clean the filter cartridges monthly to remove debris and mineral buildup which may affect the performance of the hydromassage jets, limit the flow, or trip the high limit thermostat, which will turn off the entire spa.

AVOIDING THE RISK OF HYPERTHERMIA

Prolonged immersion in hot water can result in HYPERTHERMIA, a dangerous condition which occurs when the internal temperature of the body reaches a level above normal 98.6°F (37°C). The symptoms of hyperthermia include unawareness of impending hazard, failure to perceive heat, failure to recognize the need to exit the spa, physical inability to exit the spa, fetal damage in pregnant women, and unconsciousness resulting in a danger of drowning.

WARNING

The use of alcohol, drugs, or medication can greatly increase the risk of fatal hyperthermia in hot tubs and spas.

TO REDUCE THE RISK OF INJURY

- The water in the spa should never exceed 104°F (40°C). Water temperatures between 100°F and 104°F (36°C and 40°C) are considered safe for a healthy adult. Lower water temperatures are recommended for extended use (exceeding ten minutes) and for young children. Extended use can cause hyperthermia.
- Pregnant or possibly pregnant women should limit spa water temperatures to 100°F (36°C). Failure to do so may result in permanent injury to your baby.
- Do not use spa immediately following strenuous exercise.

AVOIDING THE RISK OF SKIN BURNS

- To reduce the risk of injury, before entering a spa the user should measure the water temperature with an accurate thermometer.
- Test the water with your hand before entering the spa to be sure it's comfortable.

SAFETY SIGN

Each **HOT SPOT** spa is shipped with a SAFETY SIGN in the owner's package. The sign, which is required as a condition of Product Listing, should be permanently installed where it is visible to the users of the spa. To obtain additional SAFETY SIGNS, contact your **HOT SPRING** dealer and request Part #70798.

IMPORTANT SPA INSTRUCTIONS

The following contains important spa information, and we strongly encourage you to read and apply them.

DO:

- Use and lock the vinyl cover when the spa is not in use, whether it is empty or full.
- Follow the Spa Care and Maintenance recommendations stated in this manual.
- Use only approved accessories and recommended spa chemicals and cleaners.

DON'T

- Leave the **HOT SPOT** spa exposed to the sun without water or the cover in place. Exposure to direct sunlight can cause solar distress of the shell material.
- Roll or slide the spa on its side. This will damage the siding.
- Lift or drag the vinyl cover by using the cover lock straps; always lift or carry the cover by using the handles.
- Attempt to open the electrical control box. There are no user serviceable parts inside. Opening of the control box by the spa owner will void the warranty. If you have an operational problem, carefully go through the steps outlined in the Troubleshooting section. If you are not able to resolve the problem, contact your authorized **HOT SPRING** dealer. Many problems can easily be diagnosed over the telephone by an Authorized Service Technician.

SPA SHELL

Your **HOT SPOT** spa has an acrylic shell. Stains and dirt generally will not adhere to your spa's surface. A soft rag should easily remove most dirt. Most household chemicals are harmful to your spa's shell (see below for detailed information on cleaning agents). Always rinse off any spa shell cleaning agent with fresh water.

IMPORTANT:

1. The following products are the **ONLY** approved cleaning agents for your **HOT SPOT** spa shell: plain water, **HOT SPRING FRESHWATER** Spa Shine, or Soft Scrub[®]. The use of alcohol or any other household cleaner other than those listed to clean the spa shell surface is **NOT** recommended. **DO NOT** use any cleaning products containing abrasives or solvents since they may damage the shell surface, specifically: Simple Green[®], Windex[®] or Spa Mitt. **NEVER USE HARSH CHEMICALS!** Damage to the shell by use of harsh chemicals is not covered under the warranty. Always rinse off any spa shell cleaning agent with fresh water.
2. Iron and copper in the water can stain the spa shell if allowed to go unchecked. Ask your **HOT SPRING** dealer about a Stain and Scale Inhibitor to use if your spa has a high concentration of dissolved minerals. (**WATKINS WELLNESS** recommends **FRESHWATER** Stain & Scale Defense.)
3. Keep all cleaners out of the reach of children and use care when applying.

SAVE THESE INSTRUCTIONS

GETTING STARTED

SPA FEATURES TEMPO, RELAY & RHYTHM MODELS



1) **Standard LCD Control Panel.** The control panel is accessible from inside or outside the spa and is designed for ease of use.



2) The **Air Control** lever lets you dial in the ideal amount of air for the Precision® jets.



3) The **Water Feature** lever adjusts the amount of water that flows from the available water feature.



4) The **Hydromassage** jet with dual port rotary nozzle provides a pulsating massage.



5) The **Directional Hydromassage** jet delivers a therapeutic massage.



6) The **PRECISION** jet delivers a therapeutic massage.



7) The **multi-color LED points of light** system, you see multiple points of multi-color lighting.



8) The water feature adds beauty to your spa experience.



9) **Pillow** - All spas come with three or more pillows.



10) **FROG housing cap.**



11) **Spa Filter** provides the water filtration of the spa.



12) The **spa drain/suction.**



13) An optional factory installed speaker system is available.

GETTING STARTED

SPA FEATURES SX & TX MODELS



1) **Standard LCD Control Panel.** The control panel is accessible from inside or outside the spa and is designed for ease of use.



2) The **Air Control** lever lets you dial in the ideal amount of air for the Moto-Massage® Jet



3) The **Hydromassage** jet targets the feet to provide a direct stream massage.



4) The **Precision** jet delivers a therapeutic massage.



5) The **MOTO-MASSAGE** is a moving jet. It has a warm streams of water sweeping up and down the entire length of your back.



6) **LED** dimmable light.



7) **Pillow** - Spas come with one or more pillows.



8) **FROG** housing cap.

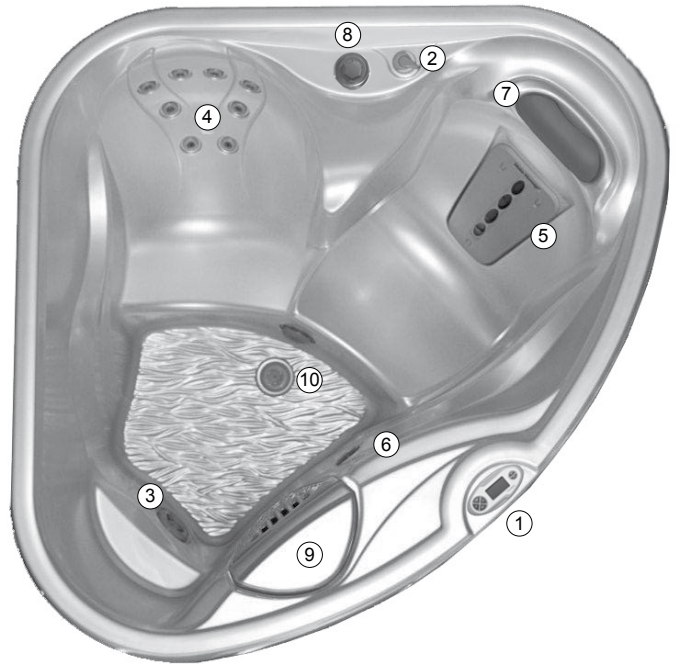

9) **Spa Filter** provides the water filtration of the spa. (not shown in overhead picture above).



10) The **spa drain**.

MOTO-MASSAGE (SX & TX MODELS ONLY)

The **MOTO-MASSAGE** jet automatically travels up and down in a sweeping motion, simulating the natural stroking effects of a manual massage. The intensity of the **MOTO-MASSAGE** jet may be adjusted by turning the **AIR CONTROL** lever.

The **MOTO-MASSAGE** jet has been factory adjusted to provide maximum hydromassage, and to achieve full vertical travel with its **AIR CONTROL** lever in the full air volume position. Should the **MOTO-MASSAGE** jet not achieve full vertical travel and the problem is not a closed air control valve or clogged filter cartridge, then your **HOT SPRING** Service Center should be contacted.

IMPORTANT: A slow or non-moving **MOTO-MASSAGE** jet may indicate that the filter cartridge pores are obstructed with dirt, body oils, or calcification. Follow the filter cartridge cleaning procedures in the Spa Care and Maintenance section of this manual.

HYDROMASSAGE JETS

The larger jets in your spa allow you to re-direct the jet stream by changing the position of the nozzle.

Regulate the force of the massage by rotating the jet face clockwise to reduce the force or counter-clockwise to increase the force. Notice that turning off the flow to some jets increases the flow to the other jets. To avoid damage to your spa's plumbing and components, **do not turn off more than half of these jets at the same time.**

PRECISION JETS

PRECISION jets are small. They are designed to perform a soft, soothing massage on your feet, calf, back and shoulders. The Air Control levers are used to change the air intensity of a group of **PRECISION** jets simultaneously.

AIR CONTROL SYSTEM

AIR CONTROL VALVE: Turning the air control lever to the left position allows for the same volume of air to flow to all individual jets and **PRECISION** jets simultaneously. The jet faceplate on the larger jets is then used to control the water intensity of each hydromassage jet.

NOTE: Always turn the air control lever to the right position anytime the spa is not being used. This will help make the spa operate more quietly and heat more efficiently when the vinyl cover is in place.

WATERFALL VALVE (TEMPO, RELAY & RHYTHM MODELS ONLY)

The **TEMPO, RELAY & RHYTHM** spas are equipped with a cascading water feature. It is activated by pressing the **JETS** button up to 3 times when the jets are off and turning the waterfall valve clockwise. The flow is regulated by turning the valve to the desired position.

When not in use turn the on/off valve to the OFF position.

QUICK START-UP INSTRUCTIONS

BEFORE YOU FILL YOUR SPA

Make sure your spa has been properly installed per all local codes, this includes the location of the spa, the foundation of the spa as well as the electrical installation of the spa. Installation instructions in the form of a Pre-Delivery Instruction booklet can be obtained from either your **HOT SPRING** dealer or online at:

www.HotSpring.com/planning-tools/pre-delivery-instructions

DO:

- Know which water treatment system you will be using and make sure you have necessary chemicals available. Read all of the instructions that come with the system.
- Have @ease Test Strips or **FRESHWATER** 5-way Test Strips Available (depending on your chosen water treatment system).
- Have pH/Alkalinity Up & Down available.
- Know the "Hardness" of your water, contact your dealer to help you with this information. See Water Quality and Maintenance for more information.
IMPORTANT: WATKINS WELLNESS does not recommend that the spa be filled with "softened" water, as this may damage the spa's equipment.
- Purchase the Clean Screen® pre-filter to remove unwanted contaminants from the tap water. This is recommended, not required.

DON'T:

- Power up the spa until it has been filled with water! Power to the spa automatically activates critical components within the spa, such as controls, heater, circulation pump, and other systems. If power is supplied to these components prior to the spa being filled, the components will be damaged, and this may result in a non-warranty component failure.
- Fill the spa with hot water or cold water with cold water temperature below 50° F (10° C)! Tripping of the high-limit thermostat may result causing your spa to stop functioning.

DON'T:

- Use your spa after filling until all of the steps listed below START-UP are completed!
- Add chlorine if treating your spa with polyhexamethylene biguanide (Biguanide, PHMB, eg. BaquaSpa®) sanitizer.

START-UP

Your **HOT SPOT** spa has been thoroughly tested during the manufacturing process to ensure reliability and long-term customer satisfaction. A small amount of water may have remained in the plumbing after testing and, as a result, may have spotted the spa shell or the spa siding prior to delivery. Before filling the spa, wipe the spa shell clean with a soft rag.

The following instructions must be read and followed exactly to ensure a successful start-up or refill.

1. **CLOSE DRAIN AND FILL THE SPA** with water through the filter compartment. Your **HOT SPOT** spa water level should be maintained at a level one inch above the highest jet in the spa.
NOTE: Remove **FROG** cap while filling to allow the air to escape the plumbing lines. Replace **FROG** cap once filled.

2. **AFTER THE SPA HAS BEEN FILLED** with water and the equipment compartment door is secured, power must be applied to the spa.

- **115 volt models:** Connect the GFCI to the waterproof receptacle and push the RESET button on the GFCI.
- **230 volt models:** Open the door of the electrical subpanel, reset the 50 amp GFCI breaker, verify the system is primed. Close and secure the subpanel door.

3. **TO CHECK THE OPERATION OF THE JET SYSTEM** and to purge any remaining air from the heating system:

TEMPO, RELAY & RHYTHM Models:

- Push the JETS button 3 times to run pumps on high speed, run for one minute.
- Push the JETS button 2 more times to shut all the jets off.

SX & TX Models:

- Push the JETS button 2 times to run the jet pump on high speed, run for one minute. Press JETS button one more time to shut the JETS off.

Weak or surging jets are an indication of a low water level condition or clogged filter cartridges.

IMPORTANT: Be sure the air Lever (see illustration in Spa Features section) is open by turning clockwise until it stops. Combination jet faces can be turned to completely shut off jet flow, these jets should be open as well.

4. **USING A TEST STRIP AND APPLICABLE CHEMICALS**, adjust Total Alkalinity (TA) to 80 ppm, Calcium Hardness (CH) to 100 ppm, then spa water pH to between 7.2 and 7.8. These procedures are listed in the "Water Quality and Maintenance" section. **When using the FROG @ease system it is required to use the @ease Test Strips.**

IMPORTANT: Always add spa water chemicals directly into the filter compartment with the jet pump on high speed for at least ten minutes. Adjusting the Total Alkalinity (TA) as the first step is important, as out-of-balance TA will affect your ability to adjust the pH correctly and will prevent the sanitizer from operating effectively.

5. **IF USING FROG @ease:** Dial a new @ease mineral cartridge to setting 6 and snap into the top space of the cartridge holder. Dial @ease SmartChlor Cartridge per the setting chart based on your gallons (see page 11).

IF USING FROG Bromine Cartridge (Canada Only): Dial the cartridge to setting 3 and snap into the bottom section of the cartridge holder. Leave the top section empty (unless using the **FROG** conditioning cartridge).

IMPORTANT: With **FROG** Bromine Cartridge shock once a week. With **FROG @ease**, shock once a month or when replacing a SmartChlor Cartridge. We recommend the **FRESHWATER** Chlorine Free Oxidizer (MPS).

6. **SUPERCHLORINATE THE SPA WATER** by adding 1½ teaspoons of chlorine (sodium dichlor) per 250 gallons (950 liters) of spa water with the spa in the Cleaning mode.

All **HOT SPOT** spas are equipped with a Cleaning mode. When the mode is activated, the jet pump will turn on and run for ten minutes (used for water maintenance). To activate the "Cleaning" mode, press the MODE (▲ or ▼) button several times until the CLEAN menu is displayed. Press the (+) button to activate the CLEAN mode feature.

7. **SET THE TEMPERATURE CONTROL**, the spa is pre-programmed to reach 100°F (38° C), and will normally do so within 18 to 24 hours. You may raise or lower the water temperature by:

- Pressing the (+) button on the control panel to raise the temperature.
- Pressing the (-) button on the control panel to lower the temperature.

Place the vinyl cover on the spa and allow the water temperature to stabilize. Make sure you secure the cover in place using the cover locks. Periodically check the spa water temperature. When the water temperature climbs above 90°F (32°C), proceed to the next step.

To prevent tampering, you can lock your desired temperature setting. Refer to the Operating section for details.

8. **IF NOT USING @ease SMARTCHLOR SYSTEM, TEST THE SPA WATER FOR CHLORINE RESIDUAL.** If the residual is between 3 and 5 ppm on the test strips, go on to the next step. If the residual is less than 3 ppm, activate the Clean cycle, and then retest, add more chlorine as necessary.

IMPORTANT: For Canada, if you are only using the **FROG** bromine cartridge, your bromine levels should be between 3.0 - 5.0 ppm.

WARNING: High sanitizer levels can cause discomfort to the user's eyes, lungs and skin. Always allow the sanitizer level to fall to the recommended range before using the spa.

IMPORTANT: Each time the spa is filled with water, you must remove and reinstall the **FROG** cap, even if you are not replacing the cartridge, in order to properly prime the jet pumps.

9. **RECHECK** the Total Alkalinity (TA) at 80 ppm, Calcium Hardness (CH) at 100 ppm, then spa water pH at between 7.2 and 7.8. using a **FRESHWATER** 5-way test strip or an @ease test strip when using @ease cartridges.

IMPORTANT: Make sure you adjust your Total Alkalinity first, as an out-of-balance condition will affect your ability to adjust the pH correctly, and will prevent the sanitizer from operating effectively.

The spa is ready for use when the spa water has circulated and the bromine level remains between 1 and 2 ppm or chlorine level remains between 0.5 and 1 ppm with @ease, or 3-5 ppm with regular chlorine.

10. **TEST WATER WEEKLY OR BEFORE EACH TIME THE SPA IS USED**

PRIMING THE PUMP(S)

Upon filling or refilling the spa, if a pump is operating and water is not flowing from any of its jets, the pump may not be properly primed. To correct, refer to the illustration below and perform the following procedures:

- Turn off power to the spa at the breaker and remove the equipment compartment door.
- **Loosen** the union on the top of the pump(s) to allow the air to escape. When water is present, hand-tighten the union.
- Turn power back on, activate the pump and check to make sure union is tight enough to keep it from leaking. Re-install equipment door.

NOTE: Equipment compartment illustrated below will vary depending on spa model.

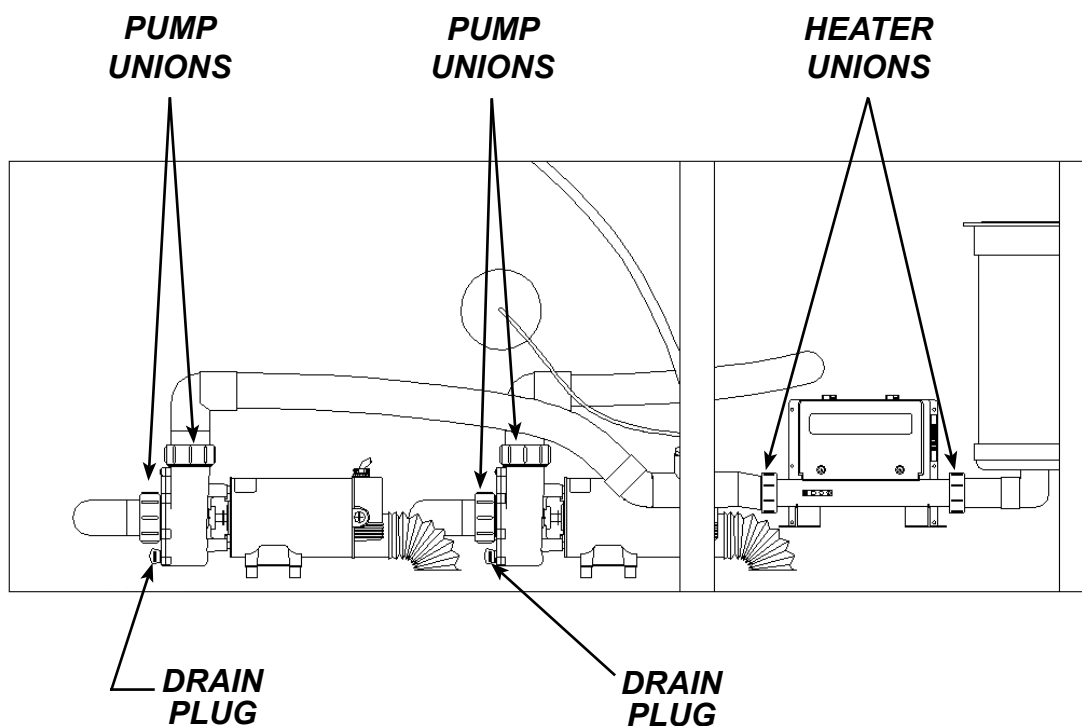

IMPORTANT

THE DRAIN CAP AND UNION FITTINGS IN THE EQUIPMENT COMPARTMENT MAY LOOSEN DURING TRANSPORTATION. TO AVOID LEAKS, PLEASE CHECK TO MAKE SURE THESE ARE HAND-TIGHT PRIOR TO FILLING YOUR SPA.

WATER QUALITY AND MAINTENANCE

BASIC INFORMATION

It's important to have clean water. Water maintenance is one of the least understood, yet most important, areas of spa ownership. Your dealer can guide you through the process of achieving and maintaining perfect water in your spa, given your local conditions.

IMPORTANT: Water Terminology can be found at the end of this section.

- **Always read & refer to the owner's manual** for complete information.
- **Test your water** with a test strip once a week, or each time the spa is used.
- **@ease users** must also use the @ease test strips.
- **Add chemicals** in small amounts to prevent overdosing the spa.
- **Use the spa only** when the chlorine level is between 0.5-1.0 ppm with @ease system, or 1-5 ppm with regular chlorine or manually add chlorine as needed.
- **It is the spa owner's responsibility** to prevent over or under chlorination.
- **Drain & refill water** 2-4 times per year depending on how often you use your spa, and how many people use it.

IMPORTANT: Remember to change your water every three to four months.

Check with your **HOT SPRING** dealer to determine if water in your region has unique qualities - such as high metal or mineral content - that should be addressed.

Your program will depend on your water's mineral content, how often you use your spa, and how many people use it.

WATER QUALITY CHART

PARAMETER	TARGET	MIN - "OK" RANGE - MAX	
pH	7.4	7.2	7.8
ALKALINITY	80 ppm	40 ppm	120 ppm
HARDNESS	100 ppm	50 ppm	150 ppm
CHLORINE	3 ppm	1 ppm	5 ppm
CHLORINE WITH @ease		0.5 ppm	1 ppm

Maintaining the water quality and the cleanliness of the filter in your spa is your responsibility. Keeping the spa water balanced prolongs the life of the spa components and will make the water more comfortable. Your dealer can guide you through the process of achieving and maintaining perfect water in your spa, given your local conditions. Your program will depend on your water's mineral content, how often you use your spa, and how many people use it. **WATKINS WELLNESS** has developed several water care systems and products to simplify water care which are available from authorized **HOT SPRING** dealers.

HOT SPRING FRESHWATER products	Vanishing Act® Calcium Remover
FROG Water Care System	CLEAN SCREEN Prefilter

*For more information visit www.hotspring.com/save-water/

CHEMICAL SAFETY

When using chemicals, read the labels carefully and follow directions precisely. Though chemicals protect you and your spa when used correctly, they can be hazardous in concentrated form. Always observe the following guidelines:

- Allow only a responsible person to handle spa chemicals. Keep them out of the reach of children.
- Accurately measure the exact quantities specified, never more. Do not overdose your spa.
- Handle all containers with care. Store in a cool, dry, well ventilated place.
- Always keep chemical containers closed when not in use. Replace caps on their proper containers.
- Don't inhale fumes, or allow chemicals to come in contact with your eyes, nose, or mouth. Wash your hands immediately after use.
- Follow the emergency advice on the product label in case of accidental contact, or if the chemical is swallowed. Call a doctor or the local Poison Control Center. If a doctor is needed, take the product container along with you so that the substance can be identified.
- Don't let chemicals get on surrounding surfaces or landscaping. Don't use a vacuum cleaner to clean up chemical spills.
- Never smoke around chemicals. Some fumes can be highly flammable.
- Don't store any chemicals in the spa equipment compartment.

HOW TO ADD CHEMICALS TO THE WATER

IMPORTANT: All spa water chemicals (other than **FROG** cartridges), including granulated dichlor, MPS, granulated pH increaser or decreaser, granulated total alkalinity increaser, liquid stain and scale inhibitor, and liquid defoamer must always be added directly into the filter compartment while the jet pump is running in its high speed mode, and it must run for a minimum of ten minutes.

To Administer Spa Water Chemicals:

1. Fold back the cover. Carefully remove and set aside the filter compartment cover.
2. On your Control Panel:
Push the MODE (▲ or ▼) button several times until the CLEAN menu is displayed. Press the (+) button to activate the CLEAN mode feature.
3. Carefully measure the recommended amount of chemical and slowly pour it into the filter compartment. Use care not to splash chemicals on your hands, in your eyes, on the spa shell surface, or on the spa cabinet.
4. Replace the filter compartment cover. After ten minutes, the jet pump will automatically shut off to complete the procedure. Close and secure the cover.

 **DANGER:** Risk of Drowning: Never leave an open spa unattended!

IMPORTANT: After administering a super chlorination treatment or non-chlorine shock to your spa, leave the cover open for a minimum of 20 minutes to allow the oxidizer gas to vent. A high concentration of trapped oxidizer gas which may exist as a result of the shock treatment (not daily sanitation) may eventually cause discoloration or vinyl degradation to the bottom of the cover. This type of damage is considered chemical abuse and is not covered under the terms of the limited warranty.

FUNDAMENTALS OF WATER MAINTENANCE (Non-FROG System)

- **Testing:** Test the water weekly or each time the spa is used with convenient **FRESHWATER** 5-way test strips or more accurate liquid/tablet reagent test kit per instructions. Critical parameters: sanitizer level, pH, Calcium Hardness (CH), and Total Alkalinity (TA). Store test equipment in a dark, cool, dry place to maintain potency.
- **Water Filtration:** The filtration used in **HOT SPOT** spas helps keep water clean by circulating sanitizer and removing waste from the spa. Regularly inspect and clean filters for peak performance.
- **Chemical Balance/pH Control:** It is important to adjust the primary water parameters (Total Alkalinity, Calcium hardness, pH) into the recommended ranges so that they are stabilized or balanced. Balance the water chemistry every time you fill the spa with new water and then during the life of that body of water. Keeping the water in balance prevents damage by holding the pH in a safe range and preventing calcium scale formation on spa equipment. A low pH can damage metal components whereas a high pH can cause high levels of calcium to form scale. Your dealer should provide a detailed water chemistry orientation soon after your new spa is filled for the very first time.

ALKALINE SPA WATER (SCALING ZONE)	8.2	ADD pH DECREASER TO LOWER pH
	7.8	
COMFORT ZONE	7.6	IDEAL
	7.4	
ACIDIC SPA WATER (CORROSIVE ZONE)	7.2	ADD pH INCREASER TO RAISE pH
	6.8	
	pH	

- The following three water components must be kept in balance to avoid damage to the spa. Do balance these components in the order they are listed here as each will help you balance the next using a minimum amount of chemicals.

1. **Calcium Hardness (CH)** – CH is the measure of the amount of dissolved calcium in the water. Low levels can make the water corrosive and high levels cause scale formation of spa components. The recommended CH reading is between **50 - 150 ppm**. If the CH level is too high, lower it with the **VANISHING ACT** calcium remover per instructions. Once in balance, the CH reading normally remains stable until new water is added. Great care must be taken when filling the spa from a water softener to ensure that the calcium remains in balance and avoid damage to the spa.
2. **Total Alkalinity (TA)** - TA is a measure of the water's ability to resist changes of pH or buffer capacity. A low TA allows the pH to fluctuate easily. The recommended TA reading is between **40 - 120 ppm**. To raise the TA, use **FRESHWATER** pH/Alkalinity Up (sodium hydrogen carbonate). To lower the TA, use **FRESHWATER** pH/Alkalinity Down (sodium bisulfate). Once the TA is balanced, it normally remains stable until the next drain/refill. We recommend you check the TA reading once per month. Raising/lowering the TA may cause the pH readings to fluctuate widely. Ignore the pH readings on the test strip while you are balancing the TA.
3. **pH** - The pH is the measure of the acidity and alkalinity. Maintaining the proper pH level will optimize the effectiveness of the sanitizer, preventing damage to the spa and physical discomfort for spa users. A low pH dissipates sanitizer, causes corrosion, and irritates spa users. A high pH level will neutralize sanitizer, promote scaling and cloud water. The recommended pH reading

is between **7.2 - 7.8**. To lower the pH level, use **FRESHWATER** pH/Alkalinity Down (sodium bisulfate). To raise the pH level, use **FRESHWATER** pH/Alkalinity Up (sodium carbonate).

- **Water Conditioners:** Spa fill water varies from location to location and user to user, therefore it is important to consult with your dealer for an appropriate program.
 - a. **VANISHING ACT** – High levels of calcium and some minerals can be removed from the water with the single use **VANISHING ACT**. High calcium levels can cause scale formation on the spa equipment and shell.
 - b. **CLEAN SCREEN** pre-filter –The **CLEAN SCREEN** pre-filter should be used at every fill and top-off to remove contaminants from the fill water, especially iron, copper, and manganese. Many water sources including well water contain high concentrations of minerals that can cause staining of the shell and plastics.
 - c. **Stain and Scale control** – For water high in calcium and minerals, it may be necessary to use an anti-scalant like Stain and Scale control. As water evaporates from your spa and new water is added, the amount of dissolved minerals like calcium, copper, iron, and manganese will increase. (Minimize evaporation by keeping the cover on the spa whenever possible.) High iron or copper content in the water may produce green or brown stains on the spa.
 - d. **Foam Inhibitors** - Soap is introduced into the spa water from users' bodies and swimming apparel and can cause the spa water to foam when the jets are used. Low levels of calcium hardness (soft water) can increase foaming. Although ozone can oxidize soap residual, it may become necessary to add Foam Inhibitors to suppress the foam. Excessive soap in the water may require a water change to resolve.
- **Oxidizers:** Ozone and Monopersulfate (MPS) are oxidizers used to prevent the buildup of contaminants, maximize sanitizer efficiency, minimize combined chlorine, and improve water clarity. They are to be used in conjunction with EPA registered sanitizers. The **FRESHWATER** III high output ozone system uses Corona Discharge technology to produce a high concentration of ozone which is injected into the spa water 24 hours per day. **FRESHWATER** Chlorine-Free Oxidizer, Monopersulfate (MPS) is a granular oxidizing chemical.
- **Sanitizers:** Maintaining the recommended residual level of an EPA registered sanitizer at all times will decrease the occurrence of unsafe bacteria and viruses in your spa water. The recommended Free Available Chlorine (FAC), the amount of available chlorine sanitizer, is **3.0-5.0 ppm or 0.5-1.0 ppm with @ease SmartChlor Chlorine System**. A low FAC can allow bacteria and viruses to grow rapidly in the warm water, and a high FAC can cause discomfort to the user's eyes, lungs, and skin. Each sanitizer carries its own instructions regarding how much to use and when to add it to the spa water. Consult your dealer for their recommendations and instructions on proper sanitizing of the spa.
 - a. **FRESHWATER** Concentrated Chlorinating Granules.
 - b. **FROG** sanitizing systems (mineral and chlorine) or (bromine for Canada Only).
 - c. Sodium Dichloro-s-Triazinetrione (sodium dichlor or chlorine).
 - d. Brominating Concentrate (one step granular bromine).
 - e. BaquaSpa® (please consult your **BAQUASPA** manual for instructions on the use of this product).

IMPORTANT: DO NOT use tri-chlor chlorine, bromo-chloro-dimethyl-hydantoin (BCDMH), or any type of compressed bromine or chlorine, acid or any type of sanitizer which is not recommended by **WATKINS WELLNESS**.

FROG WATER CARE SYSTEM

THE FROG @ease MINERAL CARTRIDGE.

This cartridge introduces minerals into the spa water, inhibiting bacteria growth.

THE FROG @ease SMARTCHLOR CARTRIDGE.

The recommended chlorine sanitizer that works in conjunction with the FROG Mineral cartridge to maintain softer, crystal clear water with up to 75% less chlorine than ordinary dichlor systems.

To monthly "shock treat" your spa, we recommend that you use either **FRESHWATER** Chlorine-Free Oxidizer, Monopersulfate (MPS) or sodium dichlor (chlorine). Sodium dichlor may be a more appropriate shock for those users that experience heavy bather load conditions.

The following optional products can be used in conjunction with the **FROG** Water Care system:

FRESHWATER Chlorine-Free Oxidizer, Monopersulfate (MPS) is an oxidizing chemical used to prevent the buildup of contaminants, maximize sanitizer efficiency, and improve water clarity. When used in conjunction with the **FROG** system it oxidizes particulates in the spa water.

IMPORTANT NOTE: **FRESHWATER** Monopersulfate (MPS) is an oxidizer, not a sanitizer.

FRESHWATER III high output ozone system is the only ozone purification system approved for installation in your **HOT SPOT** Spa. The **FRESHWATER** III high output ozone system utilizes CD technology to produce a **higher concentration of ozone than is produced by a competing** chip style CD or ultraviolet light ozone systems.

NOTE: Refer to the Start-Up instructions of your **FROG @ease SmartChlor** owner's manual, (same for **FROG Bromine, Canada only**). The owner's manual can be found with your **FROG** starter kit.

It is important to follow the recommended application and maintenance programs outlined for each product's use. If the spa is being used over an extended period or time, such as a whole afternoon or evening, additional sanitizer will be needed. **When using @ease SmartChlor the use of @ease Test Strips is also required.**

NOTE: The **FROG @ease Mineral Cartridge** or **@ease Chlorine Cartridge** are not approved for use in Canada.

TROUBLESHOOTING:

- Check water balance, pH and Total Alkalinity needs to be in the proper ranges for the @ease In-Line System to work correctly.
- If the SmartChlor Cartridge is Not empty, turn dial setting up 1 number and monitor chlorine levels for a few days while maintaining water balance. If needed, turn dial up again.
- Check SmartChlor Cartridge and replace if empty.

FROG CARTRIDGE REPLACEMENT INSTRUCTIONS

The **FROG @ease** cartridge should be replaced every 3-4 weeks, depending on User Load (shock spa after replacing the cartridge). The **FROG @ease** mineral cartridge should be replaced every 4 months or when draining and refilling the spa. After refilling the spa with water, balance the Total Alkalinity (TA), Calcium Hardness (CH) and pH to the recommended levels. Shock the spa monthly by adding **FRESHWATER Chlorine-Free Oxidizer (MPS)** non-chlorine shock or sodium dichlor (chlorine).

To replace **FROG** cartridges, follow these steps:

1. Turn off power to the spa.
2. Unscrew **FROG** cap on top edge of spa.
3. Push down on handle and turn counter-clockwise.
4. Lift cartridge holder up and out of spa.
5. Remove and discard old cartridges.
6. Turn top cap of new **@ease** Mineral cartridge to setting #6 (evaluate water in 1 week and adjust as necessary).
7. For **@ease** SmartChlor cartridge setting, see table below:

@ease SmartChlor	HOT SPOT Series Models				
	TX	TEMPO	RELAY	RHYTHM	SX
Setting	1	2	2	2	2

8. Snap **@ease** SmartChlor cartridge into the bottom of holder and snap **@ease** mineral cartridge into the top.
9. Reinstall cartridge holder into spa, push down, and twist clockwise.
10. Replace **FROG** cap.
11. Reconnect power to the spa.

USING THE FROG BROMINE CARTRIDGE (BCDMH) (Canada Only).

This is a stand-alone sanitizer that fits inside the **FROG** In-Line Sanitizing System that came with your Hot Spot Spa. Follow steps 1-5 above. Then set the **FROG** Bromine Cartridge to #3 and snap into the bottom section of the holder. Lastly, follow steps 9-11 above. When using a **FROG** Bromine Cartridge the spa should be shocked once a week.

IMPORTANT NOTE: Only use the bottom section for this cartridge or the bromine contents will dispense too quickly. Test your water and adjust the bromine cartridge daily until the proper range of 3.0 to 5.0 is established.

WARNING: High sanitizer levels can cause discomfort to the user's eyes, lungs and skin. Always allow the sanitizer level to fall to the recommended range before using the spa.

THE HOT SPOT SPA WATER MAINTENANCE PROGRAM

FILLING THE SPA WITH WATER

Use the **CLEAN SCREEN** Pre-filter to remove unwanted contaminants such as rust, dirt, detergents, and algae from the fill water. Dissolved metals, copper, iron, and manganese are also removed. Instructions are included with the **CLEAN SCREEN** Pre-filter. Always fill the spa through the filter compartment. Do not fill your spa using water from a swimming pool as pool chemicals are very different from those used in a spa and can damage your spa.

ADDING CHEMICALS TO THE WATER

All spa water chemicals, including granulated dichlor, MPS, granulated pH increaser or decreaser, granulated total alkalinity increaser, liquid

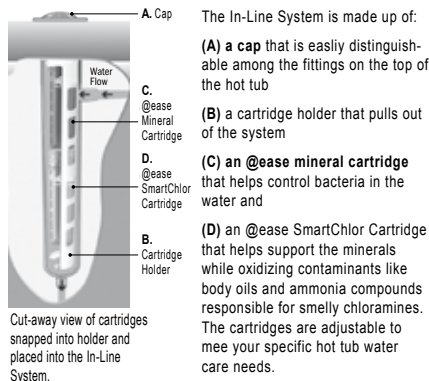

stain and scale inhibitor, and liquid defoamer must always be added directly into the filter compartment while the jet pump is running in its high speed mode, and it must run for a minimum of ten minutes with the cover off. Use the Clean button/feature to ensure that the chemicals are properly mixed when adding.

BUILDING A SANITIZER ROUTINE

During the first month of ownership, measure the sanitizer residual daily in order to establish a baseline of sanitizer needed vs. spa usage. Sanitizer needed is the amount of Free Available Chlorine needed to accommodate the number of users and their combined usage time. For example, two spa users for twenty minutes every day creates regular demand on the sanitizer that is used to determine how much sanitizer to add in order to maintain the proper residual. If the usage pattern increases dramatically with invited guests, the amount and frequency of sanitizer required increases dramatically.

PERFORMING SUPER CHLORINATION/ NON-CHLORINE SHOCK TREATMENT

A weekly or monthly super chlorination (1.5 tsp dichlor/250 gal) or shock (4lbs mps/250 gal) may be required of your chosen sanitation program. Increasing chlorine to 5 ppm for 24-48 hours removes excess waste and chloramines from the water. Sodium dichlor is 6x stronger than MPS and may be a more appropriate for those users that experience heavy bather load conditions. Operate all jets and leave the cover open for a minimum of 20 minutes to allow the oxidizer gas to vent to prevent damage and discoloration to the cover and pillows after administering a super chlorination or shock to your spa. This type of damage is considered chemical abuse and is not covered under the terms of the limited warranty.

IMPORTANT: Always allow the Free Available Chlorine to fall below 5 ppm before using your spa.

⚠ DANGER: Never leave an open spa unattended, especially if there are children present

EVERFRESH WATER CARE SYSTEM

(OPTIONAL)

The **EVERFRESH** water care system is comprised of the following products:

- **CLEAN SCREEN** Pre-filter
- **FRESHWATER** Concentrated Chlorinating Granules, Sodium Dichlor
- **FRESHWATER** Chlorine-Free Oxidizer, Monopersulfate (MPS)
- **FRESHWATER** III high output ozone system
- **FRESHWATER**_{Ag+} Silver Ion purifier

The **EVERFRESH** system introduces silver ions into the spa water via erosion of silver infused beads which inhibits bacteria growth. When combined with MPS, or chlorine, waste is oxidized and removed from the water. It is important to follow the recommended application and maintenance programs outlined for each product's use. If the spa is being used over an extended period of time, such as a whole afternoon or evening, additional sanitizer will be needed.

Required: Weekly Super Chlorinate/Shock the spa to reactivate the silver ion cartridge, allow the release of silver ions, and quickly destroy any remaining contaminants. Without this weekly shock treatment, the silver ion cartridge may stop releasing silver ions into the water.

IMPORTANT: Use only Dichlor sanitizer. Silver is not compatible with bromine and biguanides. Don't use a water clarifier. Clarifiers will cause the spa water to become cloudy.

MANUAL CHLORINE (SODIUM DICHLOR)

WATKINS WELLNESS recommends the use of **FRESHWATER** Concentrated Chlorinating Granules (sodium dichlor) for sanitizing the water. Sodium dichlor is preferred because it is totally soluble, dissolves quickly, and is nearly pH neutral. The recommended Free Available Chlorine (FAC), the amount of available chlorine to sanitize the spa, 3.0-5.0 ppm.

If the FAC is too low: Increase the FAC by adding granulated sodium dichlor.

If the FAC is too high: Allow time to pass and the FAC level will naturally drop over time.

If the spa smells of chlorine: super chlorinate or shock the spa. FAC chlorine does not have an odor whereas combined spent chlorine (chloramines) has a strong chlorine odor that can be eliminated by shocking the water.

IMPORTANT: There are several forms of stabilized chlorine available for use in spas and swimming pools. It is extremely important to choose one specifically designed for spas. Use of an incorrect product such as tri-chlor which has a very low pH (2.6) and dissolves too quickly in hot water, results in extremely high levels of chlorine that **WILL** cause damage to your spa. Use of a liquid or compressed bromine/chlorine or unapproved sanitizer **WILL** damage your spa and is specifically not covered under the terms of the limited warranty.

OZONE MAINTENANCE

Reduced or no ozone bubbles coming from heater return (clogged ozone injector) or no ozone, clean the injector:

1. Place 16 ounces of white vinegar into a cup or bucket.
2. Carefully loosen the long tubing attached to the bottom of the ozonator, located in the equipment compartment.
3. Run the spa until all 16 ounces of the vinegar are gone. This should allow an ample flow of vinegar to be run through the injector and clear the blockage.
4. Reinstall the tubing to the bottom of the ozonator.

⚠ DANGER: Place the end of the tubing into the vinegar, making certain that the end of the tubing sits at the bottom of the container.

Water chemistry damage is not covered by the warranty. The chemical levels and water quality in the spa are under your direct control. With proper basic care, the spa will provide many years of hot water relaxation. If you are unsure about any chemical or its usage in the spa, contact your Authorized Dealer, or **WATKINS WELLNESS**.

DO:

- Add all chemicals slowly into the filter compartment with the jet pump operating for ten minutes.
- Use special care if using baking soda to clean either the interior or exterior plastic surfaces.

IMPORTANT: **WATKINS WELLNESS** DOES NOT recommend the use of any floating chemical dispenser. Damage to the spa shell or components caused by a floating chemical dispenser is specifically not covered under the terms of the limited warranty. Floating dispensers can become trapped in one area and cause an over-sanitization or release large chunks of sanitizer that can very quickly chemically burn the shell and cover.

DON'T:

- Use compressed sanitizers.
- Use a floater type sanitization system as a low or no maintenance solution to your spa maintenance program.
- Use a sanitizer which is not designed for spas.
- Use swimming pool (muriatic) acid to lower pH.
- Use household bleach (liquid sodium hypochlorite).
- Broadcast or sprinkle the chemicals onto the water surface. This method may cause chemically-induced spa surface blistering (chemical abuse).

VACATION WATER CARE INSTRUCTIONS

If you plan to be away from home, follow these instructions to ensure that the water quality of your spa is maintained:

SHORT TIME PERIODS (3-5 DAYS):

1. Adjust the pH by following the instructions outlined in the Water Quality and Maintenance section.
2. Sanitize the water by following the shock procedures also listed in the Water Quality and Maintenance section.
3. Lock your cover in place using the coverlocks.
4. Upon your return, sanitize the water by following the shock procedures, and balance the pH.

LONG TIME PERIODS (5-14 DAYS):

Prior to leaving:

1. At least one day before you leave, set the temperature to its lowest level. This setting should represent an approximate water temperature of 80°F (27°C)

IMPORTANT: Spa water oxidizers such as sodium dichlor (chlorine) maintain their level of effectiveness substantially longer in warm water 80°F (27°C) than in hot water 101°F to 104°F (38°C - 40°C).

2. Adjust the pH as required. Sanitize the water by following the shock procedures.

Upon your return:

3. Sanitize the water by following the shock procedures. Return the set temperature to its original setting. The spa water will be safe for you to use once the Free Available Chlorine residual level has dropped below 5.0 ppm.

IMPORTANT: If you will not be using your spa for an extended period of time (in excess of 14 days) and an outside maintenance service (or neighbor) is not available to assist with the water maintenance, draining or winterizing of the spa is recommended. Spas equipped with our **FRESHWATER** III ozone system can extend this to 4 weeks. The **FRESHWATER** III ozone system does not guard against possible freezing damage, however.

SUPPLEMENTAL WATER MAINTENANCE

Proper water sanitation and mineral balance (pH control) are absolutely essential for a complete spa water maintenance program. Here are two other popular water additives that are optional:

Mineral Deposit Inhibitors

As water evaporates from your spa and new water is added, the amount of dissolved minerals will increase. (Minimize evaporation by keeping the cover on the spa whenever possible.) The spa water may eventually become "hard" (Calcium Hardness too high) enough to damage the heater by calcifying its surface. Proper pH control can minimize this.

Normal soap build-up will require water replacement regularly enough that mineral deposits normally are not a problem.

Occasionally, high iron or copper content in the water may produce green or brown stains on the spa. A stain and scale inhibitor may help to reduce these metals.

IMPORTANT: Well water may contain high concentrations of minerals. The use of a low water volume, extra-fine pore water filter (in-line pre-filter such as the **CLEAN SCREEN** pre-filter) will help to remove many of the larger particles during the filling of the spa. In-line pre-filters can be purchased at your local **HOT SPOT** dealer.

Foam Inhibitors

Spa water requires changing due to the buildup of soap in the water. Typically, soap will cause the spa water to foam when the jets are used. Soap is introduced into the spa water from two sources: users' bodies, which retain a soap residual after showering, and swimming apparel, which retains soap after washing.

Foam inhibitors can suppress foam, but cannot remove soap from the water. Soap is very difficult to remove from the water because soap is not oxidized by any chemical added to the spa. Only ozone can oxidize soap.

Eventually the soap build-up in the water will be concentrated, resulting in an unclean feeling on the bather's skin, which is impossible to remedy. When this occurs, it's time to drain and refill the spa. Depending on the soap input, the water should last about four months before needing to be drained.

WATER TERMINOLOGY

The following chemical terms are used in this Water Quality and Maintenance section. Understanding their meaning will help you to better understand the water maintenance process.

Bromamines: Compounds formed when bromine combines with nitrogen from body oils, urine, perspiration, etc. Unlike chloramines, bromamines have no pungent odor, and are effective sanitizers.

Bromine: A halogen sanitizer (in the same chemical family as chlorine). Bromine is commonly used in stick, tablet, or granular form.

Calcium Hardness: The amount of dissolved calcium in the spa water. This should be approximately 50 -150 ppm. High levels of calcium can cause cloudy water and scaling. Low levels can cause harm to the spa equipment.

Chloramines: Compounds formed when chlorine combines with nitrogen from body oils, urine, perspiration, etc. Chloramines can cause eye irritation as well as having a strong odor. Unlike bromamines, chloramines are weaker, slower sanitizers.

Chlorine: An efficient sanitizing chemical for spas. **WATKINS WELLNESS** recommends the use of sodium dichlor-type granulated chlorine. This type is preferred because it is totally soluble and nearly pH neutral.

Chlorine (or Bromine) Residual: The amount of chlorine or bromine remaining after chlorine or bromine demand has been satisfied. The residual is, therefore, the amount of sanitizer which is chemically available to kill bacteria, viruses and algae.

Corrosion: The gradual wearing away of metal and plastic spa parts, usually caused by chemical action. Generally, corrosion is caused by low pH or by water with levels of TA, CH, pH or sanitizer which are outside the recommended ranges.

Halogen: Any one of these five elements: fluorine, chlorine, bromine, iodine, and astatine.

MPS: Monopersulfate is the non-chlorine oxidizer used with the **FRESHWATER_{Ag+}** silver ion purification system. Not a sanitizer.

Nitric Acid: The formulation of nitric acid, a highly corrosive chemical, is a byproduct of the ozone generating process. Nitric acid is produced in very small quantities and is readily dissolved in the water stream with ozone.

Oxidizer: The use of an oxidizing chemical is to prevent the buildup of contaminants, maximize sanitizer efficiency, minimize combined chlorine and improve water clarity. See MPS and Ozone.

Ozone: Ozone is a powerful oxidizing agent which is produced in nature and artificially by man. Ozone forms no byproducts, oxidizes chloramines, and will not alter the water's pH.

pH: The measure of the spa water's acidity and alkalinity. The recommended pH for the spa water is 7.2 to 7.8. Below 7.0 (considered neutral), the spa water is too acidic and can damage the heating system. Above 7.8, the water is too alkaline and can result in cloudy water, and scale formation on the shell and heater.

ppm: The abbreviation of "parts per million", the standard measurement of chemical concentration in water. Identical to mg/l (milligrams per liter).

Reagent: A chemical material in liquid, powder, or tablet form for use in chemical testing.

Sanitizer: Sanitizers are added and maintained at recommended residuals to protect bathers against pathogenic organisms which can cause disease and infection in spa water.

Scale: Rough calcium-bearing deposits that can coat spa surfaces, heaters, plumbing lines, and clog filters. Generally, scaling is caused by mineral content combined with high pH. Additionally, scale forms more readily at higher water temperatures.

Super-Chlorination: Also known as "shock treatment." Super-Chlorination is a process of adding significant doses of a quick dissolving sanitizer ("dichlor" is recommended) to oxidize non-filterable organic waste and to remove chloramines and bromamines.

Total Alkalinity (TA): The amount of bicarbonates, carbonates, and hydroxides present in spa water. Proper total alkalinity is important for pH control. If the TA is too high, the pH is difficult to adjust. If the TA is too low, the pH will be difficult to hold at the proper level. The desired range of TA in spa water is 40 to 120 ppm.

OPERATING INSTRUCTIONS

SPA CONTROL PANEL

Your control panel consists of an LCD display and convenient touch pads that allow you to set the water temperature and adjust the skim/filter cycle settings, lock spa temp, lock all spa functions, as well as control the hydrotherapy jets, and lights.

LCD DISPLAY INVERSION

You may invert the control panel display for easier viewing from inside the spa. To invert the display the following is required: Press the MODE(▼) and (-) buttons simultaneously. By pressing the MODE(▼) and (-) buttons simultaneously a second time the screen will go back to it's original display.

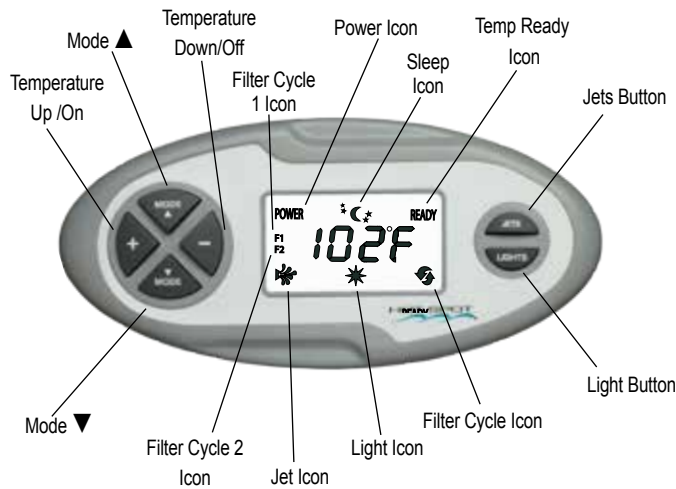

MODE BUTTON

From the Home screen use the **MODE** (▲ or ▼) button to scroll to the System, Clean, Audio (if your spa is equipped) and Tools screen. Press the (+) button to enter into the sub screens.

TEMPERATURE CONTROL

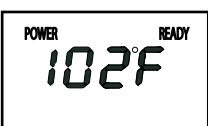

The set temperature range is from 80°F (26°C) to 104°F (40°C). Temperatures of any setting may rise slightly depending on the current use and condition of your spa, and on outside temperature. Whenever power is disconnected and then reconnected to the spa, the water temperature setting will automatically return to the last temperature entered into the program.

To increase the set temperature, press the (+) button, once for each degree of increase temperature desired. If you hold the (+) button down, the set temperature will increase by one degree every half second.

To decrease the set temperature, press the (-) button, once for each degree of decreased temperature desired. If you hold the (-) button down, the set temperature will decrease by one degree every half second.

JET PUMP CONTROL

Pressing the **JET** button for the **TEMPO**, **RELAY** & **RHYTHM** changes the jet pump functions, depending on the number of presses:

- 1st press: Two-speed jet pump runs on low speed
- 2nd press: Two-speed jet pump runs on high speed



- 3rd press: One and Two-speed jet pumps run on high speed
- 4th press: One-speed jet pump runs on high speed
- 5th press: Both jet pumps are off

Pressing the **JET** button for the SX & TX changes the jet pump functions, depending on the number of presses:

- 1st press: Two-speed jet pump runs on low speed
- 2nd press: Two-speed jet pump runs on high speed
- 3rd press: Jet pump is off

LIGHT - ON/OFF & INTENSITY CONTROLS

The light control uses four positions: High, Medium, Low, and Off. To turn on the spa light, press the **LIGHT** button. This will place all lights in the spa in the High, or maximum intensity position. When the lights turn on, the light symbol will also illuminate on the control panel display. Press the **LIGHT** button again to lower the intensity of the lights to the Medium position. Press the **LIGHT** button again to lower the intensity even more, placing the lights intensity in the Low position. Press the **LIGHT** button one more time to shut the lights off. When the lights are deactivated, the light symbol will also turn off.

If the lights are left on, they will automatically be turned off by the control system after 6 hours of continuous operation. The light symbol on the panel will also turn off when the lights are deactivated.

If the lights will not turn on, make sure **SPA LOCK** is deactivated. **SPA LOCK** disables all the controls on the control panel (see following pages for more information on **SPA LOCK**).

SYSTEM MODE

Your spa is equipped with a System Mode. This function will allow you to conveniently turn the jet(s) on high speed and the lights on maximum intensity at the same time.

To activate the System Mode, perform the following functions:

Press the **MODE** (▲ or ▼) button until **SYSON** is displayed on the screen. Press the (+) button to activate the **SYSON** mode feature. The jets and light icons will remain illuminated on the display until the system mode is deactivated.



NOTE: Once activated, the jet and light functions can still be changed by pressing the **JETS** or **LIGHT** button.

To deactivate the System Mode, press the **MODE** (▲ or ▼) button until the **SYSON** symbol is displayed on the screen. Press the (-) button to deactivate.

CLEANING MODE

All spas are equipped with a "Cleaning" mode. When the mode is activated, the jet pump in the first jet system will turn on and run for ten minutes (used for water maintenance). To activate the "Cleaning" mode, press the **MODE** (▲ or ▼) button several times until the **CLEAN** menu is displayed. Press the (+) button to activate the **CLEAN** mode feature.

NOTE: The jet icon will flash on and off while the "Cleaning" mode is active.

To stop the Cleaning Cycle before the ten minutes is complete, Press the **MODE** (▲ or ▼) button several times until the **CLEAN** menu is displayed on the screen then press the (-) button to deactivate.



NOTE: Pressing the **JETS** button will also deactivate the clean cycle and the jet icon will remain on and solid

TOOLS MENU

The TOOLS menu is one of the main menus on the control panel. Within the TOOLS menu are seven submenus, which consists of; Temp Lock, Spa Lock, Light, Econ or Summer Timer, Filter 1, Filter 2, LCD and Exit.

To enter onto the TOOLS menu, scroll through the main menus using the MODE (▲ or ▼) button until TOOLS is displayed. Press the (+) button to enter into the TOOLS submenu, use the MODE (▲ or ▼) button to scroll through the submenus. Once the desired submenu is displayed, press the (+) button to activate that submenu. To leave the TOOLS submenu, scroll through the submenu using the MODE (▲ or ▼) button until EXIT is displayed, then press the (+) button to exit the submenu.

LOCKING FEATURES

The two locking features, SPA LOCK and TEMPERATURE LOCK, are enabled from the control panel by pressing the MODE (▲ or ▼) button until TOOLS is displayed. Then press the (+) button to enter the TOOLS submenus. Use the MODE (▲ or ▼) button to scroll through the submenus to get to the locking features. Once enabled, a lock will remain active until the specific button combination is applied to disable the lock. Even if power is disconnected from the spa and soon thereafter reapplied (such as in a power outage) the lock will remain in place.

TEMPERATURE LOCK

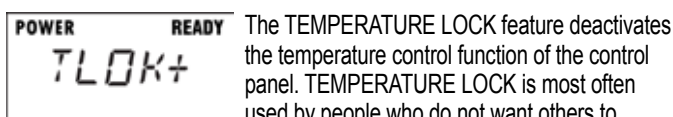

The TEMPERATURE LOCK feature deactivates the temperature control function of the control panel. TEMPERATURE LOCK is most often used by people who do not want others to

tamper with or change the set temperature of the spa water. TEMPERATURE LOCK is a submenu of the TOOLS menu

To activate the TEMPERATURE LOCK, press the MODE (▲ or ▼) button in the TOOLS submenu until the TLOK- symbol is displayed on the screen. Press the (+) button to activate the TEMPERATURE LOCK feature (TLOK+).

When the TEMPERATURE LOCK is activated, the JETS, LIGHTS and any other features your spa may have will operate normally, and the temperature setting can be viewed but can NOT be changed. If a temperature button is pressed, TLOK will display for several seconds, then turns off.

To deactivate the TEMPERATURE LOCK, press the MODE (▲ or ▼) button in the TOOLS submenu until the TLOK+ symbol is displayed on the screen. Press the (-) button to deactivate the TEMPERATURE LOCK feature.

SPA LOCK

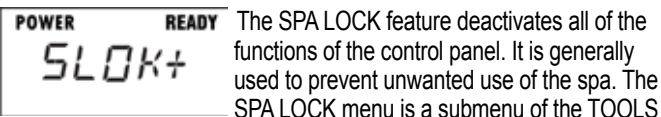

The SPA LOCK feature deactivates all of the functions of the control panel. It is generally used to prevent unwanted use of the spa. The SPA LOCK menu is a submenu of the TOOLS

menu.

To activate the SPA LOCK, press the MODE (▲ or ▼) button in the TOOLS submenu until SLOK- is displayed on the screen. Press the (+) button to activate the SPA LOCK feature.

When the SPA LOCK is activated, the buttons for the jets, temperature control, light, and any other features your spa may have are deactivated. If Jets, Light button, or (+) or (-) button is pressed, the SLOK will display for several seconds, then turns off.

To deactivate the SPA LOCK, press the MODE (▲ or ▼) button in

the TOOLS submenu until the SLOK+ symbol is displayed on the screen. Press the (-) button to deactivate the SPA LOCK feature.

LOCK OVERRIDE

The Lock Override feature is for spa users who normally keep the set temperature locked. Should the user wish to lock all spa controls temporarily, the spa lock can be applied over an already-applied temperature lock. Then, when the spa lock is removed, the temperature lock will remain on to prevent unwanted tampering with the set temperature.

LIGHT - MULTI-COLOR MENU CONTROLS (TEMPO, RELAY & RHYTHM ONLY)

Your spa lights can display a variety of different colors as well as run through a continuous sequence of colors (loop) at different speeds. To activate this function the following is required:

Press the MODE (▲ or ▼) button to scroll to the TOOLS screen. Once displayed, press the (+) button to enter the TOOLS submenu. Press the MODE (▲ or ▼) button to scroll to LIGHT screen, press the (+) button to enter DIM, screen. Press the (+) button or (-) button in the DIM screen to adjust the brightness of the lights. Press the MODE (▲) button to scroll to Color screen. Press the (+) button or (-) button in the COLOR screen as many times as desired to toggle through the different light colors. Press the MODE (▲) button to scroll to Loop screen. Press the (+) button or (-) button in the LOOP screen to select a continuous sequence of colors, the higher the loop number the faster the color sequence will run. Press the MODE (▲) button to scroll to EXIT screen. Press the (+) button in the EXIT screen to exit the LIGHT menu.

If the light is turned off while in the LOOP or COLOR mode, the same mode will exist when the light is reactivated. You will see a flashing light icon whenever your LOOP mode and light are turned on.

SUMMER MODE (OPTIONAL ON SX & TX MODELS ONLY)

If your spa is equipped with a circulation pump it will also have a Summer Mode timer. The Summer Mode timer can be activated during extremely hot summer months if it becomes difficult to maintain water temperatures low enough for comfort. Upon switching to the ON mode, the circulation pump (which can add heat to the water through normal operation) and heater will immediately shut down for the next eight hours. Additionally, the summer mode display on the control panel will activate and remain active for as long as the summer mode is on. Following this eight hour period, the circulation pump and heater will automatically re-start and will operate normally for the next sixteen hours. The circulation pump and heater will continue to turn off for an eight hour period every day that the timer remains in the ON position. In this way, the amount of heat transferred to the spa water will be minimized. When the outside temperatures begin to cool, the Summer Mode timer should be turned to the OFF position (the summer mode icon on the main display will shut off). This is the efficient 24 hour circulation mode that keeps the heater operation and operating costs to a minimum during colder/heavier usage months.

NOTE: Whenever power is disconnected and then reconnected to the spa, the Summer Mode timer will reset starting with the 8-hour shutdown mode. If a different 8-hour shut down time is desired, deactivate the Summer timer Mode, then reactivate at the beginning of the desired eight-hour shut down time.

IMPORTANT: The Summer Mode will not lower the spa's water temperature below the ambient air temperature.

To activate the Summer Mode, simply follow these steps:

1. Set the temperature control to 80°F (26°C) if desired to prevent the heater from turning on during cooler times.
2. On the control panel press the MODE (▲ or ▼) button until TOOLS is displayed. Then press the (+) button to enter the TOOLS submenus. Press the MODE (▲ or ▼) button in the TOOLS submenu until SUMMR is displayed on the screen. Press the (+) button to activate the Summer Timer mode. The Moon & Stars icon is on when in Summer Timer Mode.



The Summer Mode must be deactivated when cooler temperatures return. To do this, simply follow step 3.

3. To shut the Summer Mode off, press the MODE (▲ or ▼) button until TOOLS is displayed. Then press the (+) button to enter the TOOLS submenus. Press the MODE (▲ or ▼) button in the TOOLS submenu until SUMMR is displayed on the screen. Press the (-) button to deactivate.

SLEEP MODE

The Sleep Mode operation is a feature that minimizes pump operation during quiet evening hours. For example, if Filter Cycle 1 (F1) is set to activate at 8:00 a.m., by default, Filter Cycle 2 (F2) will activate at 8:00 p.m. (12 hours later). During 8:00 p.m. to 8:00 a.m., if the spa should call for heat, the pump and heater will activate to heat the spa under normal temperature demand. However, when in Sleep Mode, should the spa call for heat, the pump and heater will be suspended after Filter Cycle 2 (F2) until the activation of Filter Cycle 1 (F1), at 8:00 a.m. to minimize pump activation during quiet evening hours.

Important: Power-up of the spa starts the F1 sequence. In order for the sleep mode to work in the evening hours, the spa must be powered up in the early morning hours. The Sleep Mode will always be active the 6-12 hours between the end of (F2) and the beginning of (F1) depending on how the filter cycle program is set.

Note: If temperature drops below 80° F (27° C), heater will automatically activate to prevent spa from freezing.

To activate Sleep Mode feature:

- A. Press the MODE (▲ or ▼) button until the TOOLS screen is displayed.
- B. Press the (+) button to enter the TOOLS submenus.
- C. Press the MODE (▲ or ▼) button until ECON is displayed.
- D. Press the (+) button to activate Sleep Mode. Moon & Stars icon will appear on the screen of the control panel, indicating this feature has been activated.



To deactivate this feature, simply repeat steps A-C then press the (-) button.

FILTER CYCLES (NON CIRCULATION PUMP MODELS ONLY)

When the spa is first powered up, the automatic filter cycle will wait 10 minutes before starting. Your spa will automatically turn the first filter cycle on for 60 minutes on low speed. The second filter cycle will activate for 30 minutes, 12 hours later. The filter cycle icon, F1 or F2 will be displayed in the control panel during the filter cycle.

NOTE: When using @ease SmartChlor, the initial recommended minimum filter cycle setting is 2 hours 30 minutes, twice a day (5 hours total). You may adjust this setting based on your bather load.

NOTE: The optional FRESHWATER III ozone system only works during the filter cycle.

To modify the length of either filter cycle:

- A. Press the MODE (▲ or ▼) button until the TOOLS menu is displayed.
- B. Press the (+) button to enter the TOOLS submenus.
- C. Press the MODE (▲ or ▼) button until FILT1 or FILT2 is displayed.
- D. Press the (+) button to enter FILT1 or FILT2. F1 or F2 icon will flash.
- E. Using the (+) or the (-) button, adjust the desired filter cycle time, from 0 to 6 hours.

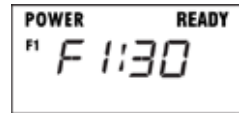

The filter cycle will activate the jet pump on low speed for the entire cycle. When activated, the filter cycle icon on the display is turned on. If the temperature exceeds the set point by three degrees F for more than three hours, the system will cancel the filter cycle for the remaining filter cycle time. Should the temperature cool down to 1.5 degrees F (1 degree C) below the set point before the end of the cycle, the cycle will resume for the rest of the time. Should you use the spa during the filter cycle by placing the jet pump on high speed, the Filter icon and Jets icon will be on. Once the jet pump has been shut off, a ten minute tranquil mode begins (Filter & Jet icons are off during tranquil mode while F1 or F2 remain lit). The Filter and Jet icons will come back on once the tranquil mode ends if the filter cycle timer is still on.

BRIGHTNESS - LCD

If you would like to change the brightness of the Control Panel screen:

- A. Press the MODE (▲ or ▼) button until the TOOLS menu is displayed.
- B. Press the (+) button to enter the TOOLS submenus.
- C. Press the MODE (▲ or ▼) button until LCD is displayed.
- D. Press the (+) button to enter into the LCD menu.
- E. Using the (+) or the (-) button, adjust the desired screen brightness.

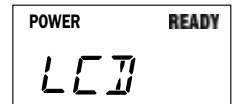

AUDIO MENU (OPTIONAL)

The following applies to spas that have an optional wireless audio system installed:

When the wireless audio system has been installed on the spa, the control panel can be used to control the audio system. The following information demonstrates how to navigate the music menu by using the spa's control panel.

AUDIO MENU

Once the music system is installed, an AUDIO menu will be accessible on the control panel screen.

To access the menu, press the MODE (▲ or ▼) button until AUDIO is displayed.

BASIC CONTROL PANEL OPERATION

1. To enter into a sub-menu press the (+) button.
2. To move to the next menu press the MODE (▲) button
3. To exit from any sub-menu, press MODE (▲ or ▼) button as many times as necessary until EXIT is displayed then press the (+) button to exit that sub-menu.



TO TURN AUDIO SYSTEM ON/OFF

From the AUDIO screen:

1. Press the (+) button to display POWR -.
2. Press the (+) button to display POWR + and turn the audio system ON. Press the (-) button to display PWR - and turn the audio system OFF.

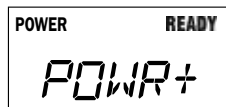

IMPORTANT: The power can take a few seconds to turn on or off.

TO PAIR BLUETOOTH

On your device, find *My Spa BTXR*. If you DO NOT see this, another device may already be connected (see To Disconnect Bluetooth on following page).

1. Press the MODE (▲ or ▼) button until the SETUP screen is displayed.
2. Press the (+) button to display one of three audio sources, BLUE, TV, AUX in the setup menu. Bluetooth should be selected.
3. Press the MODE (▲ or ▼) button until the PAIR+ screen is displayed.
4. Press the (+) button followed by pressing "connect" next to *My Spa BTXR* on your device to pair.

After pairing, you will be ready to use your Bluetooth device. Only one paired Bluetooth device will work at a time.

TO ADJUST VOLUME

From the AUDIO screen:

1. Press the (+) button to display POWR.
2. Press the MODE (▲) button to display VOL.
3. Press the (+) button to increase volume and the (-) button to decrease volume.

NOTE: Volume range is from 0-40. No number displayed indicates Volume is OFF.

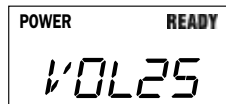

TO PAUSE/PLAY

From the AUDIO screen:

1. Press the (+) button to display POWR.
2. Press the MODE (▲) button to display VOL.
3. Press the MODE (▲) button to display PLAY.
4. Press the (+) button to start the song or the (-) button to pause the song.

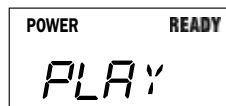

TO CHANGE TRACK

From the AUDIO screen:

1. Press the (+) button to display POWR.
2. Press the MODE (▲) button to display VOL.
3. Press the MODE (▲) button to display PLAY.
4. Press the MODE (▲) button to display TRCK +.
5. Press either (+) button or (-) button to change the track (song).



TO GO TO SETUP MENU

From the AUDIO screen:

1. Press the (+) button to display POWR.
2. Press the MODE (▲) button to display VOL.
3. Press the MODE (▲) button to display PLAY.
4. Press the MODE (▲) button to display TRCK +.
5. Press the MODE (▲) button to display SETUP.

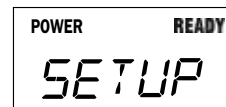

TO CHANGE AUDIO SOURCE

From the SETUP screen:

1. Press the (+) button to display one of three audio sources, BLUE, TV, AUX.
2. Press the (+) button to raise to the next source or press the (-) button to lower to the next source. Go to the source you will be using.

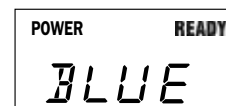

NOTE: Blue = Bluetooth®. To use the Bluetooth screen, your audio Bluetooth device must be paired with the spa.

TO ADJUST TREBLE

From the SETUP screen:

1. Press the (+) button to display one of four audio sources, IPOD, TV, AUX, BLUE.
2. Press the MODE (▲) button to display TRE -5 to +5.
3. Press (+) button to raise the Treble or press (-) button to lower the treble.

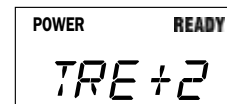

TO ADJUST BASS

From the SETUP screen:

1. Press the (+) button to display one of four audio sources, IPOD, TV, AUX, BLUE.
2. Press the MODE (▲) button to display TRE.
3. Press the MODE (▲) button to display BAS -5 to +5.
4. Press (+) button to raise the Bass or press (-) button to lower the Bass.

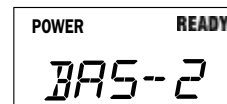

TO ADJUST BALANCE

From the SETUP screen:

1. Press the (+) button to display one of four audio sources, IPOD, TV, AUX, BLUE.
2. Press the MODE (▲) button to display TRE.
3. Press the MODE (▲) button to display BAS.
4. Press the MODE (▲) button to display BAL -5 to +5.
5. Press (+) button to raise the Balance # or press (-) button to lower the Balance #.



TO ADJUST SUBWOOFER

From the SETUP screen:

1. Press the (+) button to display one of four audio sources, IPOD,TV, AUX, BLUE.
2. Press the MODE (▲) button to display TRE.
3. Press the MODE (▲) button to display BAS.
4. Press the MODE (▲) button to display BAL.
5. Press the MODE (▲) button to display SUB 0 to 11.
6. Press (+) button to raise the subwoofer # or press (-) button to lower the subwoofer #.



TO DISCONNECT BLUETOOTH (RESET)

From the SETUP screen:

1. Press the (+) button to display one of three audio sources, BLUE,TV, AUX.
2. Press the MODE (▲ or ▼) button until RSET+ is displayed.
3. Press (+) button to disconnect any device using the spa music system so that another paired device may be used. This is also necessary when trying to pair multiple devices because pairing is NOT possible when another device is connected to the music system.

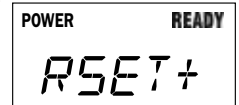

TO PAIR BLUETOOTH DEVICE

From the SETUP screen:

1. Press the (+) button to display one of three audio sources, BLUE,TV, AUX.
2. Press the MODE (▲ or ▼) button until PAIR is displayed.
3. Press (+) button followed by pressing "connect" next to *My Spa BTXR* on your device to pair.
4. Press the MODE (▲) button to display the signal strength (0-5) between your device and the spa.

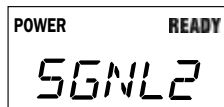
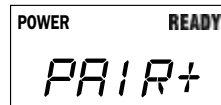

JET MENU

TEMPO (MODEL TEM)

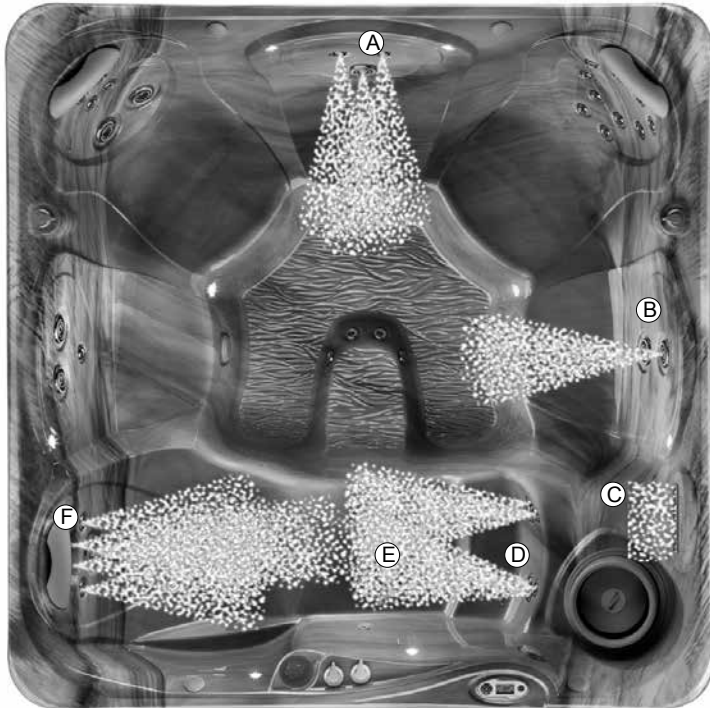

Jet Pump 1

- A. 2 Directional **PRECISION** Jets and 1 Directional Hydromassage Jet
- B. 2 Directional Hydromassage Jets
- C. 1 Water Feature
- D. 6 Directional **PRECISION** Jets in Lounge (foot Jets)
- E. 4 Directional **PRECISION** Jets in Lounge (calf Jets)
- F. 1 Directional Hydromassage Jet, 2 Rotary Hydromassage Jets and 4 Directional **PRECISION** Jets



Jet Pump 2

- A. 10 Directional **PRECISION** Jets
- B. 2 Directional Hydromassage Jets and 1 Directional **PRECISION** Jet
- C. 4 Directional **PRECISION** Jets and 2 Rotary Hydromassage Jets
- D. 4 Directional **PRECISION** Jets in footwell.

JET MENU RELAY (MODEL REL)



Jet Pump 1

- A. 2 Directional **PRECISION** Jets and 1 Directional Hydromassage Jet
- B. 8 Directional **PRECISION** Jets
- C. 2 Directional Hydromassage Jets
- D. 1 Water feature.
- E. 3 Directional **PRECISION** Jets
- F. 2 Directional **PRECISION** Jets



Jet Pump 2

- A. 4 Directional **PRECISION** Jets (calf Jets)
- B. 2 Directional Hydromassage Jets, 1 Rotary Hydromassage Jet and 2 Directional **PRECISION** Jets
- C. 2 Directional **PRECISION** Jets and 2 Rotary Hydromassage Jets
- D. 2 Directional **PRECISION** Jets

JET MENU

RHYTHM (MODEL RHY)

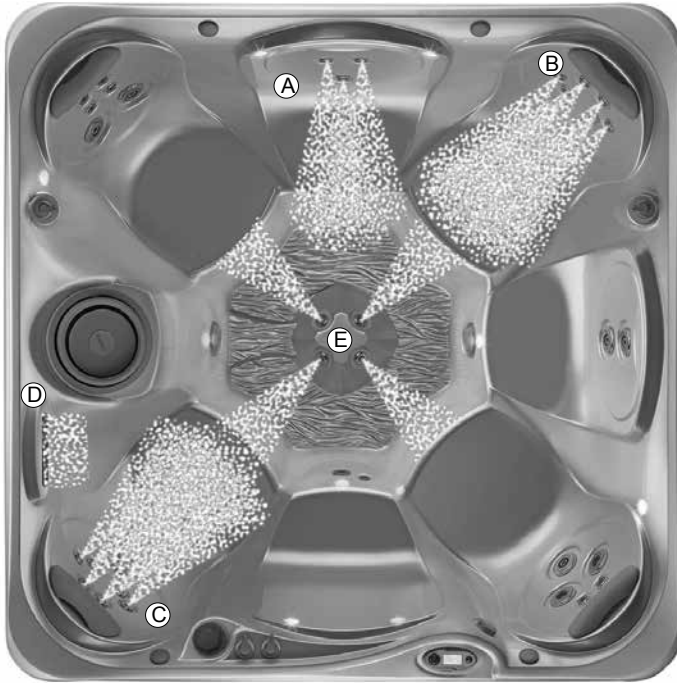

Jet Pump 1

- A. 3 Directional **PRECISION** Jets
- B. 8 Directional **PRECISION** Jets
- C. 6 Directional **PRECISION** Jets and 1 Directional Hydromassage Jet
- D. 1 Water feature.
- E. 4 Directional **PRECISION** Jets

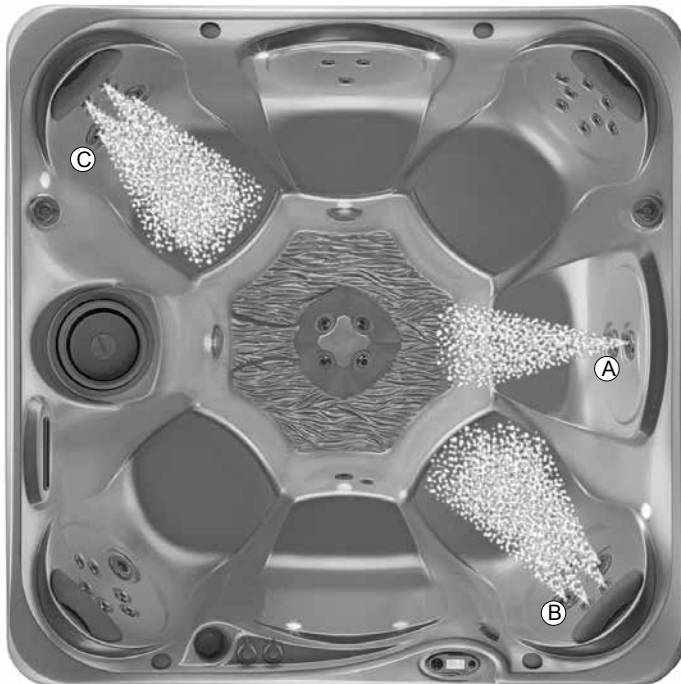

Jet Pump 2

- A. 2 Directional Hydromassage Jets
- B. 2 Directional Hydromassage Jets, 1 Rotary Hydromassage Jet and 2 Directional **PRECISION** Jets
- C. 2 Rotary Hydromassage Jets and 4 Directional **PRECISION** Jets

JET MENU

SX (MODEL SX)



Jet System

- A. 8 Directional **PRECISION** Jets
- B. 1 **MOTO-MASSAGE** Jet
- C. 2 Directional **PRECISION** Jets
- D. 2 Directional Precision Jets

JET MENU

TX (MODEL TX)



Jet System

- A. 8 Directional **PRECISION** Jets
- B. 1 **MOTO-MASSAGE** Jet
- C. 1 Rotary Hydromassage Jet

SPA CARE AND MAINTENANCE

Your **HOT SPOT** spa is manufactured from the highest quality, most durable materials available. Even so, the spa care and maintenance program you develop will ultimately determine how long your spa, and its individual components, will last. Regular maintenance and following the advice in this section will help you to protect your investment.

DRAIN & REFILL INSTRUCTIONS

IMPORTANT: It is NOT recommended to refill your spa when the ambient temperature goes below 50° F (10° C).

1. Disconnect the spa from the power supply by tripping both of the GFCI breakers located in the subpanel. Unplug power cord for 115V models.
2. Locate the drain valve for the spa (lower front of the spa) and remove the drain cap. Attach the inlet of a garden hose to the drain valve (to avoid flooding of the foundation surrounding the spa) and route the outlet of the hose to an appropriate draining area. Spa water with a high sanitizer level may harm plants and grass.
3. Open the drain valve by turning the knob. The spa will drain by gravitational flow.
IMPORTANT: All **HOT SPOT** spa models will drain to the bottom of the suction fitting, use vacuum side of shop vac to remove remaining water. Any water remaining within the plumbing or equipment after draining will only need to be removed if the spa is being winterized.
4. When empty, inspect the spa shell and clean as required. (Follow the Care of the Exterior instructions.)
5. Close the drain valve by reinstall the drain cap.
6. Install new filter or clean existing with **FRESHWATER** filter cleaner.
7. Refill the spa through the filter compartment using the **CLEAN SCREEN** pre-filter.
IMPORTANT: Refill water temperature must be between 50° - 70°F to avoid high-limit tripping.
8. Follow the Quick Start-Up instructions on page 6.

COLD WATER REFILL

Should it be necessary to drain and refill your spa in temperatures below 50° F (10° C), the spa may go into a High Limit Protection mode (causing your spa to stop functioning) if the tap water is below 50° F (10° C). Blending warm water with the cold tap water so it exceeds 50° F (10° C) during the refilling process will prevent the spa from going into the High Limit Protection mode if that is an option for you.

PREVENTION OF FREEZING

Your spa has been designed and engineered for year-round use in any climate. In some areas, extremely cold temperatures (below 10°F) combined with strong wind, may cause partial freezing of the jet pump, even though the water inside the spa remains at the selected temperature. The energy efficiency of the spa may also decrease during these cold periods, as the heater will cycle more frequently. As an additional precaution against partial freezing of some of the components, the equipment compartment can be insulated with an insulating kit (available from your local dealer). This insulating kit will also help to maximize the spa's energy efficiency.

NOTE: When warmer weather returns (approx. 60°-70°F, 15.5°-21°C), the insulating kit must be removed to prevent overheating of the jet pump.

WINTERIZING YOUR SPA

If you leave the spa unused for a long period of time in severely cold weather, you should drain the spa and winterize it to avoid accidental freezing due to a power or equipment failure.

⚠ DANGER: Use only Propylene Glycol as your anti-freeze (available at most RV or marine supply stores). This is non-toxic. Never use an automobile anti-freeze (Ethylene Glycol) since it is toxic!

⚠ WARNING: Failure to follow these instructions correctly can lead to freeze damage not covered by warranty. It is strongly recommended that you contact your local dealer to perform this service

1. Drain your spa following the Draining Your Spa section in the owner's manual. Open waterfall valve.
2. Remove the filter cartridge, clean and store in a dry place.
IMPORTANT: These additional instructions must be utilized when draining and winterizing your spa in climates where the temperature falls below 32°F (0°C). A five (5) gallon (19 liters)

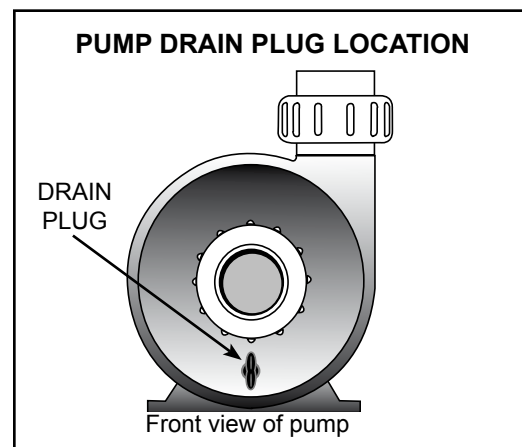

combination (vacuum/blower) wet/dry shop vac must be used to effectively remove water that is trapped inside the plumbing lines.

3. Attach the vacuum hose to the vacuum side of the shop vac. Vacuum all openings and orifices as follows:
 - a. Jet openings: start with the jets at the top and move downward (if suction is coming from another jet, block off the other jet using a large rag this will help pull out the water that is trapped deeper inside the main line).
 - b. Filter suction fittings and filter compartment.
 - c. Main drain outlet (it may be necessary to cover the drain grate tightly with a rag when vacuuming the main drain to ensure water is drawn completely from the internal plumbing system).
4. Thoroughly dry the spa shell with a clean towel.
5. Replace the main drain cap.
CAUTION: Use only Propylene Glycol as your anti-freeze. This is non-toxic. Never use an automobile anti-freeze (Ethylene Glycol) since it is toxic!
6. Using a long-extension funnel, pour anti-freeze into all standpipes, filter suction fittings, jet orifices and water feature orifices. Add enough anti-freeze to ensure adequate protection – in many cases, you will see the liquid in the orifice, or coming out of another location.

- Close the spa cover and fasten the cover tie downs. Cover the spa cover with two pieces of plywood to evenly distribute the weight of snow and ice. Secure a plastic sheet, or tarp, over the spa cover and plywood.
- Replace the equipment access door, if removed.

OPENING INSTRUCTIONS:

- Remove plywood and plastic sheet. Open the spa cover by unfastening the cover tie downs.
- Follow the Start-up and Refill Procedures in the Operating Instructions section of the Owner's Manual. Do not install filters to prevent them from exposure to the anti-freeze.
- As part of this process, superchlorinate the spa water by adding three teaspoons of chlorine (sodium dichlor) per 250 gallons of spa water into the filter compartment. This is twice the normal amount of chlorine needed for superchlorination. This extra amount of chlorine is needed to destroy the anti-freeze.

NOTE: A defoamer may be needed to decrease the amount of foam caused by the anti-freeze.

- Drain your spa to ensure removal of anti-freeze. Do not drain water on grass or plants due to excessive chlorine level.
- After the spa has completely drained, re-install your filter and follow the Start-up and Refill Procedures in the Operating Instructions section of the Owner's Manual.

IMPORTANT: Always keep spa covered when not in use, whether it is empty or full.

FILTER SYSTEM

The filter lid on the spa is NOT designed to support heavy weight loads and should not be used as a seat. In extreme cases, the lid could crack and break. This occurrence is considered abuse and is not covered under the warranty.

HOT SPOT spas are equipped with one filter cartridge, sized to meet the needs of the jet pump system.

At least once a week, check and clean the skimmer basket and weir to ensure proper filter flow. Remove leaves, foreign matter, and debris. It is very important to keep your spa filter cartridge clean and free of particles to ensure proper water flow. A clean filter permits the hydrotherapy system to function properly and also allows more efficient filter cycles. Depending on how frequently your spa is used, we recommend cleaning the spa filter cartridge every four weeks. If this is not done, the filter may clog and restrict water flow, which causes improper filtration and poor jet performance.

⚠ WARNING: To reduce the risk of injury to persons using the spa, DO NOT remove the suction fittings (filter standpipes) located in the filter compartment and do not sit on the filter lid, in extreme cases the lid could crack and break. This occurrence is considered abuse and is not covered under warranty.

SECONDARY SUCTION SCREEN

Located in the foot well of your spa are three secondary suction screens. The screen is used as a filter to prevent dirt from circulating through the system.

⚠ WARNING: Do not use the spa with the suction screens removed.

FILTER CARTRIDGES REMOVAL & CLEANING

- Disconnect the spa from the power supply by turning the power to the spa OFF.
- Remove any floating items from within the filter compartment.
- Turn the filter retainer handle (located on the top of the filter cartridge) counterclockwise until the retainer can be removed from the filter standpipe.
- Remove the filter retainer, cover and cartridge (cover only used on **TEMPO, RELAY & RHYTHM** spa models).

SERVICE NOTE: Never remove the filter standpipe when debris is present in the filter compartment. Debris may find its way into the internal plumbing which may result in blockage. NEVER REMOVE SUCTION FITTINGS!

- Always clean the filter using a filter degreaser, such as **HOT SPRING FRESHWATER** Filter Cleaner, to remove mineral and oil build-up.

Simply soak the filter in the degreaser according to the package directions, then place the filter on a clean surface and spray until clean using a garden hose. It may be necessary to rotate the filter while spraying to remove any debris lodged between the filter pleats.



- To reinstall the filter cartridge, reverse the order of steps in which it was removed. Do not overtighten.

⚠ WARNING: Do not use the spa with the filter cartridges, or filter standpipe(s) removed!

CARE OF THE SPA PILLOWS

The spa pillows will provide years of comfort if treated with care. They have been positioned above the water level to minimize the bleaching effects of chlorinated water, and other spa water chemicals. To extend their life, whenever the spa shell is being cleaned, the spa pillows should be removed and cleaned. Body oils can be removed with a mild soap and water solution. ALWAYS rinse off the spa pillows thoroughly to remove any soap residue. The pillows can be conditioned with **HOT SPRING** Cover Shield after cleaning. If the spa is not going to be used for a long period of time (that is during a vacation, or if the spa is winterized), or when the spa water is being super-chlorinated, the spa pillows should be removed until the next spa use.

To remove and replace the spa pillows:

- Carefully lift one end of the pillow away from the spa shell.
- Continue lifting one end until all pillow retainers are released from the pillow.

IMPORTANT: Just pulling the pillow straight up and out of the shell recess will eventually damage the pillow. This abuse is not covered under warranty.

3. To reinstall the spa pillow, carefully bend the pillow slightly to allow one of the pillow retainers to slip into the recess in the back of the pillow.
4. Keeping the pillow slightly bent, slide the other pillow retainer into the recess in the back of the pillow.
5. After all the pillow retainers are in place, press the pillow down into the recess in the spa shell.

CARE OF THE EXTERIOR

SPA SHELL

Your **HOT SPOT** spa has an acrylic shell. Stains and dirt generally will not adhere to your spa's surface. A soft rag or a nylon scrubber should easily remove most dirt. Most household chemicals are harmful to your spa's shell (see below for detailed information on cleaning agents). Always rinse off any spa shell cleaning agent with fresh water.

IMPORTANT:

1. The following products are the **ONLY** approved cleaning agents for your **HOT SPRING** spa shell: plain water, **HOT SPRING FRESHWATER** Spa Shine, or Soft Scrub®. The use of alcohol or any other household cleaner other than those listed to clean the spa shell surface is **NOT** recommended. **DO NOT** use any cleaning products containing abrasives or solvents since they may damage the shell surface, specifically: Simple Green®, Windex® or Spa Mitt. **NEVER USE HARSH CHEMICALS!** Damage to the shell by use of harsh chemicals is not covered under the warranty. Always rinse off any spa shell cleaning agent with fresh water.
2. Iron and copper in the water can stain the spa shell if allowed to go unchecked. Ask your **HOT SPRING** dealer about a Stain and Scale Inhibitor to use if your spa has a high concentration of dissolved minerals. (**WATKINS WELLNESS** recommends **FRESHWATER** Stain & Scale Defense.)
3. Keep all cleaners out of the reach of children and use care when applying.

CARE OF THE SPA CABINET

The simulated wood cabinet consists of a rigid polymer that combines the durability of plastic, with the beauty of wood.

Cleaning of simulated wood consists of simply spraying the cabinet with a mild soap and water solution to remove any stains and residue.

CARE OF THE SPA COVER

⚠ WARNING: The cover is a manual safety cover that meets or exceeds all prevailing requirements of ASTM 1346-91 for spa safety covers when installed and used correctly as of the date of manufacture. Non-secured, or improperly secured covers are a hazard.

Open the cover to its fully open position before use.

VINYL COVER

The vinyl spa cover is an attractive, durable foam insulation product. Monthly cleaning and conditioning are recommended to maintain its beauty.

To clean and condition the vinyl cover:

1. Remove the cover from the spa and gently lean it against a wall or fence.
2. With a garden hose, spray the cover to loosen and rinse away dirt or debris.
3. Using a large sponge and/or a soft bristle brush, and using a very mild soap solution (one teaspoon dishwashing liquid with two gallons of water), or baking soda (sodium bicarbonate), scrub the vinyl top in a circular motion. Do not let the vinyl dry with a soap film on it before it can be rinsed clean.
4. Scrub the cover's perimeter and side flaps. Rinse clean with water.
5. Rinse off the underside of the cover with water only (use no soap), and wipe it clean with a dry rag.
6. To condition the cover after cleaning, apply a thin film of **HOT SPRING** Cover Shield to the vinyl surface and buff to a high luster.

IMPORTANT: To remove tree sap, use cigarette lighter fluid (not charcoal lighter fluid). Use sparingly, and rinse with a saddle soap solution immediately afterwards, then wipe dry.

DO:

- Remove snow buildup to avoid breakage of the foam core from the additional weight of the snow.
- Lock cover lock straps to secure the cover when the spa is not in use.

DON'T:

- Drag or lift the spa cover using either the flaps, or the cover lock straps.
- Walk, stand, or sit on the cover.
- Place any metal or heat transferring object on the cover or place any type of plastic tarp or drop cloth over the cover as this may result in a melted foam core, which would not be covered under the warranty.
- Use any lifting mechanisms, chemicals, or cleaners except those recommended by **WATKINS WELLNESS**, or its Authorized Sales and Service Dealer.

COVER LIFTER SYSTEM

Clearance required behind cover when open:

CoverCradle® & CoverCradle II 24"	UpRite® 7"	Lift 'n Glide® 14"
--------------------------------------	---------------	-----------------------

HOW TO OPEN THE VINYL COVER

IMPORTANT: Never attempt to open or remove the vinyl cover by grasping or pulling on the skirting or cover lock straps. The skirting will tear, and torn skirting is not covered under the terms of the warranty.

Check for ice build-up around the gas springs and pivot points of the retractable cover system. Ice buildup may damage system components.

⚠ WARNING: The vinyl cover and retractable cover system are not recommended for use in wind conditions reaching above 25 mph (40 kmh).

IMPORTANT: If your spa is located in an area susceptible to high winds, additional coverlock straps may be installed to minimize wind damage to the cover.

1. With the cover lock straps unfastened, place one hand under the cover skirting, between the spa and cover, to break the cover's vacuum seal. Then, fold the front half of the cover over onto the back half.

2. If no rear access is available, stand to the side of the spa directly adjacent to the hinge area of the folded cover.
 - a. **For the COVERCRADLE retractable cover systems:** Using both hands, cup one hand under the lower half of the cover (just above the water) and place the other along the side of the cover, just above the skirt. Gently push (do not lift) with both hands towards the opposite rear corner of the cover (diagonally). As the cover opens, the gas springs will allow the cover to come to a gentle stop.
 - b. **For the UPRITE retractable cover system:** Simply lift the cover at its center hinge, allowing it to move to the back of the spa and to rest gently there.
 - c. **For the LIFT 'N GLIDE retractable cover system:** Slightly lift the cover at front of spa, glide (push back until it stops), fold cover in half and lift cover moving it to the back of the spa. Insert locking pin into side of lifter to prevent accidental closure.

IMPORTANT: When opening a cover with a retractable cover system, only use one of these three specific methods. Do not attempt to open the cover in any other way. Damage caused by improper opening or closing of the cover is not covered under the terms of the limited warranty.

HOW TO CLOSE THE COVER

1. Standing along side the cover, place one hand on the upper corner of the cover and gently push forward in the direction of the spa. The cover will rotate forward to cover half of the spa.
IMPORTANT: For the UPRITE or LIFT 'N GLIDE retractable cover system, disengage the locking mechanism(s) before pushing the cover forward.
2. Unfold the cover by lifting the handle located on the top (front) half of the cover. Allow the unfolded half to fall down onto the spa. The air pressure created by the cover falling will keep the vinyl skirting from being trapped between the cover and the spa shell.

ELECTRICAL REQUIREMENTS

IMPORTANT: Fill the spa with water before turning on the power.

Your **HOT SPOT** spa has been carefully designed to give you maximum safety against electrical shock. Connecting the spa to an improperly wired circuit will negate many of the spa's safety features. Improper wiring may also cause electrocution, risk of fire, and other risks of injuries. Please read and follow the electrical installation requirements and instructions for your specific spa model completely!

- The TX operates on 115 volts 15 amp 60 Hz.
- The SX operates on 115 volts 20 amp 60 Hz.

Both the SX and TX can also be converted to either 115 volt 30 amp or 230 volt 50 amp.

When the TX or SX spas are connected to 115 volts 15/20 amp, the heater will provide approximately 1000 watts of heat, only when the pump is operating in LOW speed and the thermostat is calling for heat. When the TX, SX spas are connected to 115 volts 30 amp, the heater will provide approximately 1000 watts of heat when the pump is operating in LOW or HIGH speed and the thermostat is calling for heat. When the TX or SX are connected to 230 volts 50 amps, the heater will provide approximately 4000 watts of heat when the pump is operating in LOW or HIGH speed and the thermostat is calling for heat.

- The **TEMPO**, **RELAY** and **RHYTHM** models require a dedicated 230 volt power supply.

230 VOLT PERMANENTLY CONNECTED MODELS

(**TEMPO**, **RELAY**, & **RHYTHM** only)

HOT SPOT spas must be wired in accordance with all applicable local electrical codes. All electrical work should be done by an experienced, licensed electrician. We recommend the use of appropriate electrical conduit, fittings, and wire for all circuits.

The diagram below illustrates how to wire 230 volt permanently connected spa models:

- An electrical subpanel containing two GFCI breakers is included with each 230 volt spa. We recommend that this subpanel be used to supply power to the spa.
- The subpanel requires a 50 amp, single phase, 230 volt, four wire service (two line, one neutral, one ground). The grounding conductor must not be less than #10 AWG. Refer to local codes and to NEC 250-122 table.

- Mount the subpanel in the vicinity of the spa, but not closer than five feet away, in accordance with all local codes. (N.E.C. 680-38 to 41-A-3)

Once your spa has been filled with water, turn it on and test all of the circuit breakers.

IMPORTANT: If both breakers immediately trip, verify that the wires are correctly connected. Each breaker should be tested prior to each use. Here's how:

1. Push the "TEST" button on each GFCI breaker, and observe it click OFF.
2. Wait 30 seconds, then push the breaker switch to the OFF (down) position (to ensure that it has completely disengaged), then push the breaker switch to the ON (up) position. If you don't wait 30 seconds, the spa's power indicator may continue to blink – try again.

If any of the GFCI breakers fails to operate in this manner, your spa may have an electrical malfunction, and you may be at risk of electrical shock. Turn off all circuits and do not use the spa until the problem has been corrected by an authorized service agent.

⚠ WARNING: Removing, or bypassing any GFCI breaker will result in an unsafe spa and will void the spa's warranty.

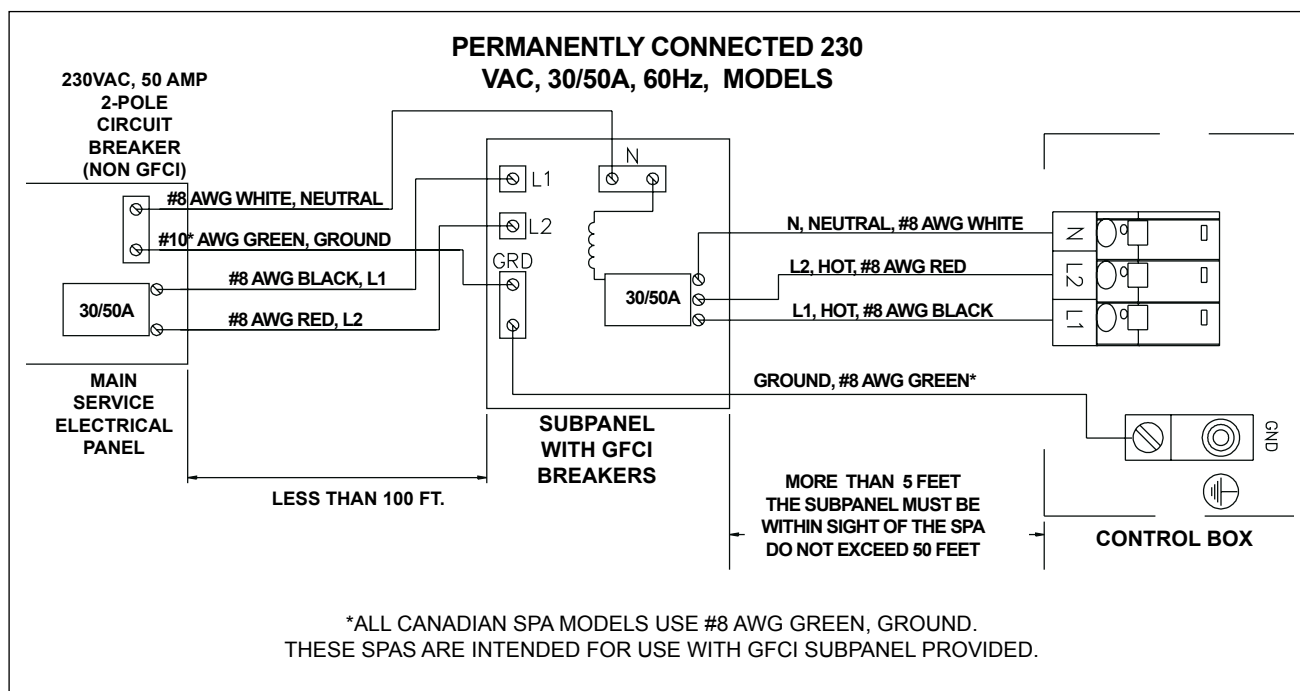

230 VOLT CONVERSION 30 OR 50 AMP (SX & TX ONLY)

Conversion instructions

NOTE: An Authorized **HOT SPOT** Spa Technician must reconfigure spa using the soft jumpers.

A licensed electrician must install the sub-panel (available from your **HOT SPOT** Spa Dealer) to supply power to the spa. The sub-panel must be placed in sight of the spa, at a minimum distance of 5 feet (1.5 m) away.

Power Jumper Position

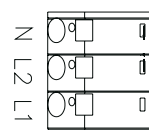

See Wiring Illustration below

230 VAC Wiring (50A Converted)

2 Position Power Jumper must be removed on the Terminal Block to operate 230 VAC Spa Models

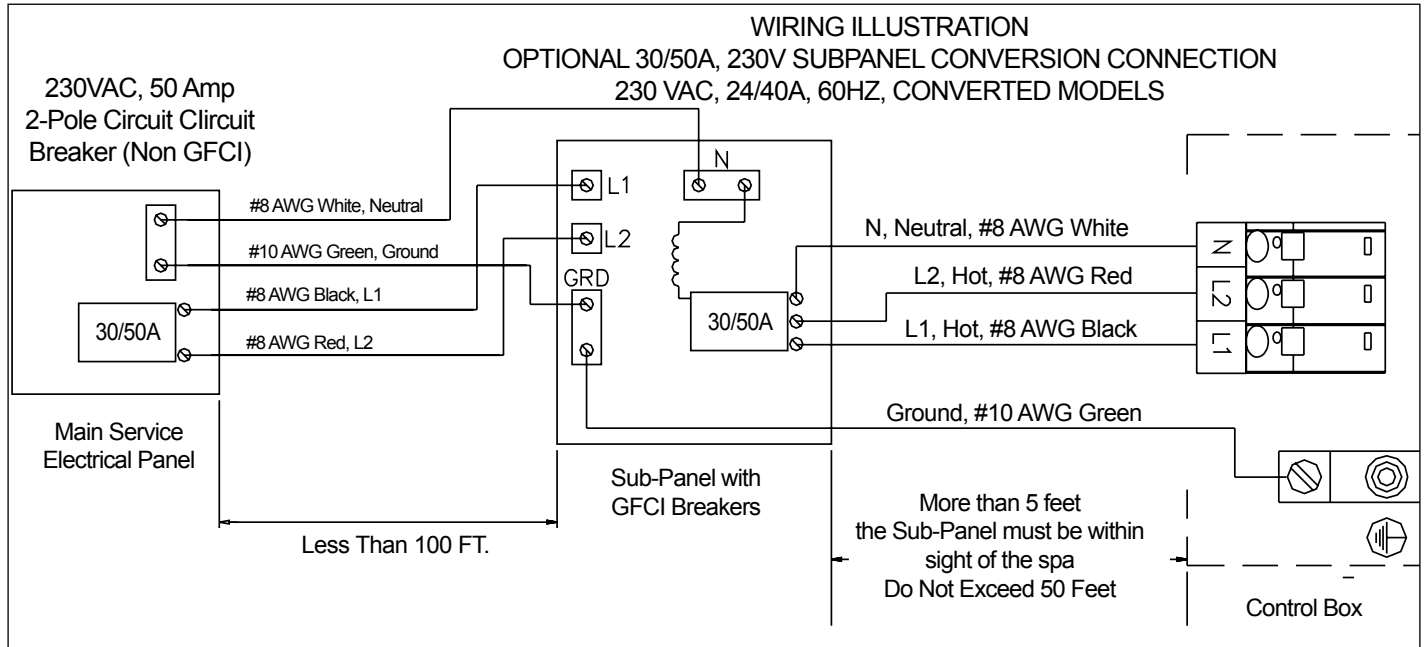

115 VOLT CONVERSION 30 AMP (SX & TX ONLY)

Conversion instructions

NOTE: An Authorized **HOT SPOT** Spa Technician must reconfigure spa using the soft jumpers.

A licensed electrician must install the sub-panel (available from your **HOT SPOT** Spa Dealer) to supply power to the spa. The sub-panel must be placed in sight of the spa, at a minimum distance of 5 feet (1.5 m) away.

Power Jumper Position

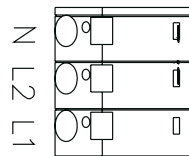

See Wiring Illustration on next page

115 VAC Wiring (30A Converted)

Terminal Block Power Jumper

2 Position Power Jumper must remain on the Terminal Block to operate 115 VAC Spa Models

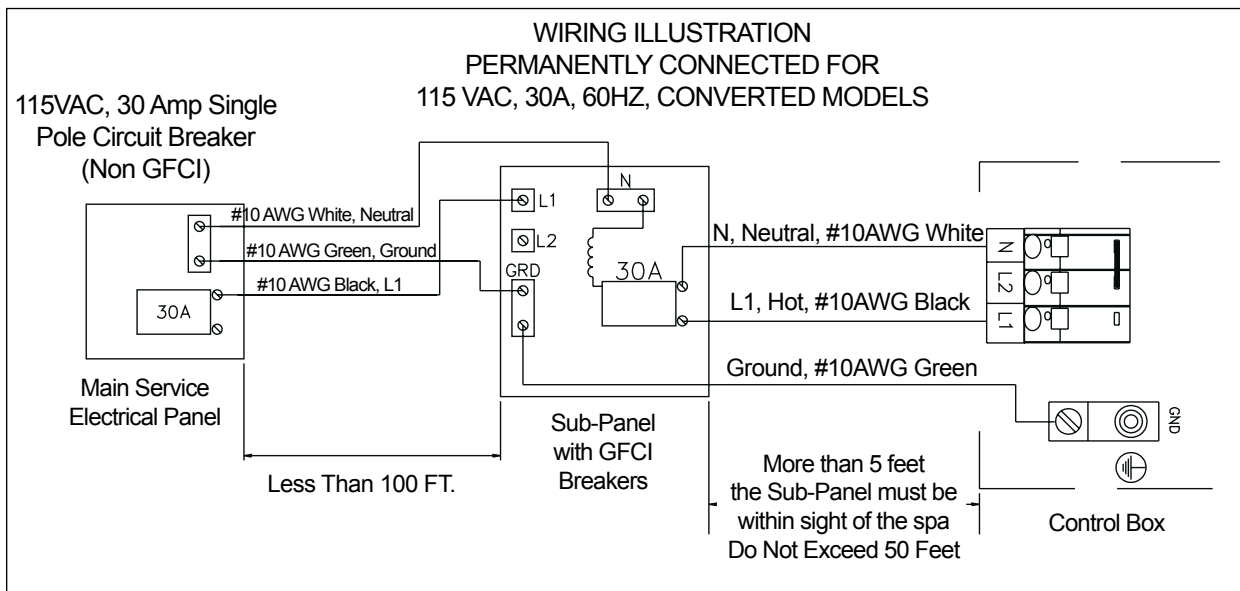

115 VOLT GFCI SX & TX

The Ground Fault Circuit Interrupter (GFCI) is a safety device that is designed to detect as little as 5 milliamps ($\pm 1\text{mA}$) of electrical current leakage to ground. **WATKINS WELLNESS** recommends that the GFCI be tested prior to each use to ensure it is functioning correctly. With the spa connected to the power supply, push the "Test" button. The spa should stop operating and the GFCI power indicator will go out. Wait 30 seconds and then reset the GFCI by pushing the Reset button. The GFCI power indicator will turn on, restoring power to the spa. If the interrupter does not perform in this manner, it is an indication of an electrical malfunction and the possibility of an electric shock. Disconnect the plug from the receptacle until the fault has been identified and corrected.

IMPORTANT: Never use the GFCI as a means to disconnect power to the spa (always unplug it). If the GFCI is tripped while the spa is plugged in, and a power outage occurs, when power returns the GFCI will automatically reset and power will flow to the spa.

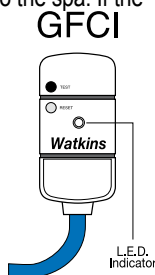

115 VOLT OPERATION (60Hz ONLY)

The spa must be connected to a dedicated 115 volt, 15 or 20 amp, GFCI protected, grounded circuit. The term "dedicated" means the electrical circuit is not being used or shared for any other electrical items (patio lights, appliances, garage circuits, etc.). If the spa is connected to a non-dedicated circuit, overloading will result in "nuisance tripping" at the main panel. This requires frequent resetting of the breaker switch at the house electrical breaker panel and introduces the possibility of damage or failure of spa equipment.

NEVER CONNECT THE SPA TO AN EXTENSION CORD!

A pressure wire connector is provided on the exterior surface of the control box, inside the spa. This is to permit the connection of a ground bonding wire between this point and any metal equipment, enclosures,

reinforced concrete pad, pipe, or conduit within 5 feet of the spa (if needed to comply with local building code requirements). The bonding wire must be at least a #10-AWG solid copper wire. Bond the spa to all exposed metal equipment or fixtures, handrails, and concrete pad per N.E.C. Article 680 and all local codes.

INSTALLATION INSTRUCTIONS

All 115 volt spa models come equipped with approximately 15 feet of useable power cord (this is the maximum length allowed by Underwriters Laboratory and the National Electric Code). When the spa is installed, the power cord will come out of the bottom of the equipment compartment door. For your safety, when the electrician is installing the single electrical outlet and waterproof cover, the outlet should be no closer than 5 feet (1.5 meters) and no farther than 10 feet from the spa [reference National Electrical Code 680-6a(1) and 680-41a].

The Ground Fault Circuit Interrupter (GFCI) is located at the end of the power cord. This device is for your protection. It is very important to protect it from rain and other moisture. Test once a month, with the plug connected to the power supply,

1. Push the "TEST" button on the GFCI breaker. The spa should stop operating and the GFCI power indicator will go out.
2. Wait 30 seconds, then push the "RESET" button. Power will be restored to the spa and the GFCI power indicator will turn on.

If the GFCI fails to operate in this manner, your spa may have an electrical malfunction, and you may be risking electrical shock. Turn off all circuits and do not use the spa until the problem has been corrected by an authorized service agent.

⚠️ WARNING: Removal of the GFCI from the spa's power cord will result in an unsafe spa and will void the spa's warranty.

IMPORTANT: Should you ever find the need to move or relocate your **HOT SPOT** spa, it is essential that you understand and apply these installation requirements. Your **HOT SPOT** spa has been carefully engineered to provide maximum safety against electric shock. Remember, connecting the spa to an improperly wired circuit will negate many of its safety features.

SERVICE INFORMATION

GENERAL INFORMATION

Your **HOT SPOT** spa has been designed to provide years of trouble-free use. As with any appliance, problems may occasionally occur that require the expertise of a qualified service person. Though such simple repairs as resetting a GFCI switch or breaker, high limit thermostat, or pressure switch, or replacing a light bulb may not require a service call, they may indicate that a more serious condition exists. These conditions may require an experienced service person. Before calling for service, please refer to the Troubleshooting Guide.

NOTE: Always retain your original sales receipt for future reference.

GFCI AND HIGH LIMIT THERMOSTAT

If your spa fails to operate at any time, the following items should be checked:

1. Check the power supply to the spa.
2. Check the GFCI (located at the end of the cord in standard models or in the electrical subpanel in 30 amp converted models) and see if it has tripped. If a GFCI has tripped, reset it. If it will not reset, this may be an indication of a ground fault (short circuit) within the electrical components. Contact an Authorized Service Technician for a complete diagnosis.
3. If, upon checking the GFCI you find it has not tripped, check the house breaker panel and ensure the main breaker for the electrical circuit supplying the spa has not tripped. If it has, this is an indication that either the circuit was overloaded or a ground fault exists between the breaker panel and the spa receptacle. Contact a qualified electrician.
4. If, upon checking the main house breaker, you find no failures, the heater high-limit thermostat should be checked. Tripping of the heater high-limit thermostat is normally a result of one or a combination of any of these problems: 1) blockage within the system plumbing, 2) switch malfunction in the heater circuit, or 3) the low speed mode of the jet pump is not functioning.
5. If the heater high-limit has tripped, the control panel display will display - - - -. Reset the heater high-limit by allowing the water to cool and disconnecting power to the spa for at least thirty seconds. If the heater high-limit continues to trip, contact an Authorized Service Technician for a complete diagnosis.

If the spa does not function and the GFCI or GFCI breaker and heater high-limit have not tripped, then the problem should be referred to an Authorized Service Technician. Refer to the Troubleshooting Guide for additional service information.

MISCELLANEOUS SERVICE INFORMATION

The jet pump is equipped with an overload cut-off switch, which is designed to protect the pump from overheating. If the pump shuts itself off in a new spa, it is usually the result of one, or a combination of, the following factors:

High Temperature: During the summer months, especially in warmer climates, the ambient temperature contributes to excessively high temperatures within the equipment compartment.

Improper House Wiring: If the spa is not connected to a dedicated circuit, or is connected to an extension cord, or the house wiring is undersized, the pump may starve for voltage and therefore may draw more amperage and generate excessive heat. This will often cause the circuit breaker to trip repeatedly.

IMPORTANT:

1. If the pump is shutting down due to excessive heat, make sure the equipment compartment has adequate ventilation. The air gap at the bottom and the jet pump vent at the bottom left corner must not be blocked. Should your jet pump continue to shut off after short periods of use, contact a qualified service technician.
2. The **HOT SPOT** spa is equipped with a safety suction spring valve which will break the prime of the jet pump if both suction fittings are obstructed.

ACTS INVALIDATING WARRANTY

The limited warranty is void if the **HOT SPOT** Spa has been subjected to alteration, misuse or abuse, or if any repairs on the spa are attempted by anyone other than an authorized representative of **WATKINS WELLNESS**. Alteration is defined as any component or plumbing change, electrical conversion, or the addition of any non-approved sanitation, or water purification device, or heating system which contributes to a component failure, unit failure, or unsafe operating condition. Misuse and abuse shall include any operation of the spa other than in accordance with **WATKINS WELLNESS** printed instructions, or use of the spa in an application for which it is not designed; specifically: use of the spa in a non-residential application; damage caused by operation* of the spa at water temperatures outside the range of 35°F and 120°F (2°C and 49°C); damage caused by a dirty, clogged, or calcified filter cartridge; damage to the spa surface caused by the use of Tri-Chloro Chlorine, BCDMH, chemical tablets in a floater, acid, or any other spa chemicals, or spa surface cleaners which are not recommended by **WATKINS WELLNESS**; damage caused by allowing undissolved spa sanitizing chemicals to lie on the spa surface (no spa surface material can withstand this kind of abuse); damage to components or spa surface caused by improper water chemistry maintenance; and damage to the spa surface caused by leaving the spa uncovered while empty of water and in direct exposure to sunlight (this may cause solar heating distress in warm weather regions). These are considered abuses and may invalidate this warranty.

*Operation of the spa **DOES NOT** mean "use" of the spa! **WATKINS WELLNESS** does not recommend using the spa if the water temperature is above or below the spa's control panel temperature range.

DISCLAIMERS

WATKINS WELLNESS shall not be liable for loss of use of the **HOT SPOT** spa or other incidental or consequential costs, expenses, or damages, which may include but are not limited to, the removal of a permanent deck or other custom fixture. Any implied warranty shall have a duration equal to the duration of the applicable warranty stated above. Under no circumstances shall **WATKINS WELLNESS**, or any of its representatives, be held liable for injury to any person, or damage to any property, however arising.

WATKINS WELLNESS *CUSTOMER SERVICE*

If you have any questions about any aspect of your **HOT SPRING** spa set-up, operation or maintenance that have not been answered by this manual, consult your **HOT SPRING** dealer.

WATKINS WELLNESS can be reached at: 800-999-4688 (Extension 8432), Monday through Friday, 8 am to 5-pm Pacific Standard Time (PST), or e-mail customerservice@watkinsmfg.com.

TROUBLESHOOTING

Should you experience any problem whatsoever, do not hesitate to contact your authorized **HOT SPRING** dealer. On the following page are some tips to help you to diagnose and rectify some more common sources of trouble, if you choose to do so.

TROUBLESHOOTING

Should you experience any problem, do not hesitate to contact your authorized **HOT SPRING** dealer. Here are some tips to help you to diagnose and rectify some more common sources of trouble yourself, if you choose to do so.

GENERAL OPERATION TROUBLESHOOTING GUIDE		
Problem	Probable causes	Solutions
Entire spa is inoperative	<ul style="list-style-type: none"> Power failure GFCI tripped 	<ul style="list-style-type: none"> Check power source Reset GFCI; call for service if it will not reset
Spa does not heat; jets and light operate. Display shows" =====" POWER & READY icon flashes	<ul style="list-style-type: none"> Pressure switch is open and should be closed Pressure switch senses flow through heater even though the jet pump is off 	<ul style="list-style-type: none"> Check for clogged filter. The pressure switch will reset when the flow of water through the heater has been restored. Call for service if the pressure switch trips frequently. Contact an Authorized Service Technician
READY icon flashes	<ul style="list-style-type: none"> Control Sensor open or shorted 	<ul style="list-style-type: none"> Contact an Authorized Service Technician
Spa does not heat; jets and light operate. Display shows" -----" POWER & READY icon flashes	<ul style="list-style-type: none"> Pressure switch is closed and should be open 	<ul style="list-style-type: none"> Contact an Authorized Service Technician
Jets weak or surging	<ul style="list-style-type: none"> Spa water level too low Filter clogged / suction screens clogged Jet nozzles closed / Air valve closed 	<ul style="list-style-type: none"> Add water Clean filters / Clean suction screens Open jet nozzles / Open air valve
Light inoperative	<ul style="list-style-type: none"> Bad connection 	<ul style="list-style-type: none"> Contact an Authorized Service Technician
MOTO-MASSAGE (SX & TX ONLY) jet inoperative or erratic	<ul style="list-style-type: none"> AIR CONTROL valves closed Filter clogged 	<ul style="list-style-type: none"> Open AIR CONTROL lever Clean filter
Display shows " - - - - " (Entire spa is inoperative.) POWER icon flashes	<ul style="list-style-type: none"> Heater high-limit thermostat tripped 	<ul style="list-style-type: none"> Disconnect power for at least thirty seconds to reset heater high limit. If it will not reset, check for clogged filter. If tripping continues, call for service.
After filling or refilling the spa: a jet pump is operating, but water is not flowing from any of its jets.	<ul style="list-style-type: none"> Pump is not properly primed. 	<ol style="list-style-type: none"> Turn off power to the spa at the breaker and remove the equipment compartment door. Loosen the union on the top of the pump(s) (as seen on page 8) to allow the air to escape, the hand-tighten the union(s). Turn power back on, activate the pump and check to make sure union is tight enough to keep it from leaking. Re-install pump and equipment doors. <p>OR: Remove and reinstall the FROG cap.</p>

SPA WATER MAINTENANCE TROUBLESHOOTING GUIDE		
Problem	Probable causes	Solutions
Cloudy Water	<ul style="list-style-type: none"> Dirty filters Excessive oils / organic matter Improper sanitization Suspended particles / organic matter Overused or old water 	<ul style="list-style-type: none"> Clean filters Shock spa with sanitizer Add sanitizer Adjust pH and/or alkalinity to recommended range Run jet pump(s) and clean filters Drain and refill the spa
Water Odor	<ul style="list-style-type: none"> Excessive organics in water Improper sanitization Low pH 	<ul style="list-style-type: none"> Shock spa with sanitizer Add sanitizer Adjust pH to recommended range
Chlorine Odor	<ul style="list-style-type: none"> Chloramine level too high Low pH 	<ul style="list-style-type: none"> Shock spa with sanitizer Adjust pH to recommended range
Musty Odor	<ul style="list-style-type: none"> Bacteria or algae growth 	<ul style="list-style-type: none"> Shock spa with sanitizer—if problem is visible or persistent, drain, clean and refill the spa
Organic buildup / scum ring around spa	<ul style="list-style-type: none"> Build-up of oils and dirt 	<ul style="list-style-type: none"> Wipe off scum with clean rag – if severe, drain the spa, use a spa surface and tile cleaner to remove the scum, and refill the spa
Algae Growth	<ul style="list-style-type: none"> High pH Low sanitizer level 	<ul style="list-style-type: none"> Shock spa with sanitizer and adjust pH Shock spa with sanitizer and maintain sanitizer level
Eye Irritation	<ul style="list-style-type: none"> Low pH Low sanitizer level 	<ul style="list-style-type: none"> Adjust pH Shock spa with sanitizer and maintain sanitizer level
Skin Irritation / Rash	<ul style="list-style-type: none"> Unsanitary water Free chlorine level above 5 ppm 	<ul style="list-style-type: none"> Shock spa with sanitizer and maintain sanitizer level Allow free chlorine level to drop below 5 ppm before spa use
Stains	<ul style="list-style-type: none"> Total alkalinity and/or pH too low High iron or copper in source water 	<ul style="list-style-type: none"> Adjust total alkalinity and/or pH Use a metal deposit inhibitor
Scale	<ul style="list-style-type: none"> High calcium content in water – total alkalinity and pH too high 	<ul style="list-style-type: none"> Adjust total alkalinity and pH – if scale requires removal, drain the spa, scrub off the scale, refill the spa and balance the water

SPA SPECIFICATIONS

Spa Model	Footprint Dimension	Height	Effective Filter Area	Heater (Watts)	Water Capacity	Dry Weight	Filled Weight*	Dead Weight*	Electrical Requirements
TEMPO (Model TEM) Seats 6 Adults	7'5" x 7'5" 2.26 m x 2.26 m	39" 99 cm	65 square feet	4,000	415 gallons 1,575 liters	910 lbs. 415 kg	5,420 lbs. 2,470 kg	120 lbs per sq. foot	230 volt, 30/50 amp Single phase GFCI protected circuit
RELAY (Model REL) Seats 6 Adults	7'0" x 7'0" 2.13 m x 2.13 m	36.75" 93.5 cm	65 square feet	4,000	345 gallons 1,300 liters	835 lbs. 380 kg	4,765 lbs. 2,160 kg	115 lbs per sq. foot	230 volt, 30/50 amp Single phase GFCI protected circuit
RHYTHM (Model RHY) Seats 7 Adults	7'0" x 7'0" 2.13 m x 2.13 m	36.75" 93.5 cm	65 square feet	4,000	355 gallons 1,350 liters	835 lbs. 380 kg	5,020 lbs. 2,290 kg	125 lbs per sq. foot	230 volt, 30/50 amp Single phase GFCI protected circuit
SX (Model SX) Seats 3 Adults	6'0" x 6'0" 1.83 m x 1.83 m	33" 84 cm	30 square feet	1,000 or 4,000	285 gallons 1,075 liters	720 lbs. 325 kg	3,620 lbs. 1,640 kg	125 lbs per sq. foot	115 volt, 20 amp dedicate GFCI protected circuit OR 115 volt, 30 amp requires 30 amp subpanel GFCI protected circuit OR 230 volt, 30/50 amp Single phase GFCI protected circuit
TX (Model TX) Seats 2 Adults	5'8.5" x 5'8.5" 1.74 m x 1.74 m	29" 74 cm	30 square feet	1,000 or 4,000	140 gallons 525 liters	525 lbs. 240 kg	2,045 lbs. 925 kg	95 lbs per sq. foot	115 volt, 15 amp dedicate GFCI protected circuit OR 115 volt, 30 amp requires 30 amp subpanel GFCI protected circuit OR 230 volt, 30/50 amp Single phase GFCI protected circuit

 **WARNING: WATKINS WELLNESS** suggests a structural engineer or contractor be consulted before the spa is placed on an elevated deck.

* IMPORTANT: The "Filled weight" and "Dead weight" of the spa includes the weight of the occupants (assuming an average occupant weight of 175lbs).

This manual contains installation, operating, maintenance and service information for the following 2019 HOT SPOT Spa models:

US/CANADIAN MODELS

TEMPO	(MODEL TEM)
RELAY	(MODEL REL)
RHYTHM	(MODEL RHY/RHYC)
SX	(MODEL SX/SXC)
TX	(MODEL TX/TXC)

©2018 Watkins Wellness All Rights Reserved. Hot Spot, Tempo, Relay, Rhythm, Precision, No-Fault, FreshWater, FreshWater_{Ag+}, Clean Screen and Vanishing Act are trademarks of Watkins Wellness. BaquaSpa is a trademark of Arch UK Biocides Limited. iPod is a trademark of Apple, Inc. FROG is a registered trademark of King Technology.



Watkins Wellness[®]

Feel good. Live well.™

**Vista, California
USA**



hotspring.com

303761.19 A (6/1)